

EZCP213-40

Call 800-321-7800 or visit us online at www.nookindustries.com to configure and order your EZCP213-40 today!

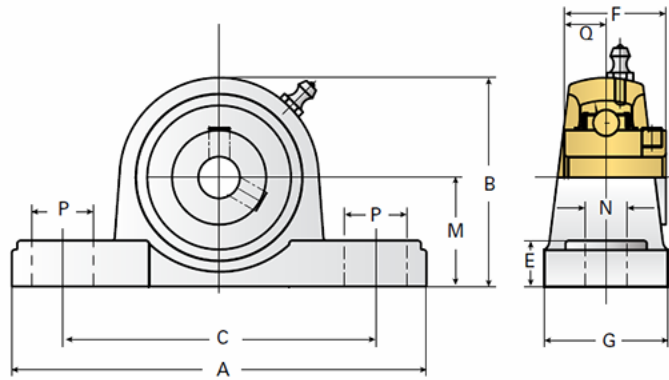

Details

Bore Diameter [in] 2.50

Dimensions

A [mm]	265
B [mm]	150
C [mm]	203
E [mm]	27
F [mm]	65.1
G [mm]	70
M [mm]	76.2
N [mm]	25
P [mm]	30
Q [mm]	25.4

Product Compatibility Selection

BSJ	-
MSJ	30-MSJ
SS-MSJ	-
EM-BSJ	-
EM-MSJ	-
Bevel	-
Link Shafting	-