

G3-BSJ-UK 3:1

Call 800-321-7800 or visit us online at www.nookindustries.com to configure and order your G3-BSJ-UK 3:1 today!

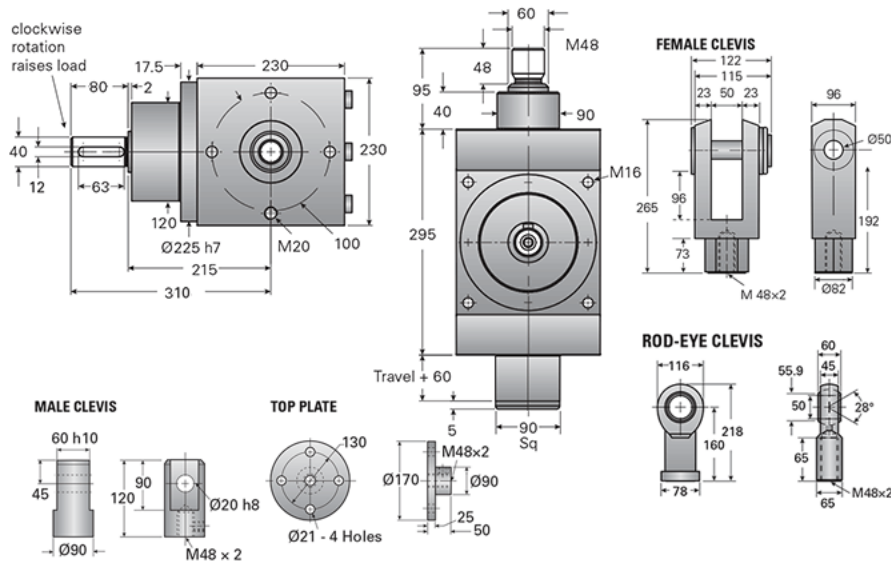

Details

Capacity [kN]	90
Gear Ratio	3:1
Raise for One Turn of Worm [mm]	3.33
Torque to Raise 1 kN [Nm]	0.71
Tare Drag Torque [Nm]	4.30
Lifting Screw Diameter [mm]	63
Screw Lead [mm]	10
BackDrive Holding Torque [Nm]	31.47

Performance Specifications

Maximum Input Torque [Nm]	1600
Dynamic Load Ca [kN]	76.0

Weight

Base 0 Travel [kg]	36.30
Per 100mm of Travel [kg]	2.12
Grease [kg]	1.00