

G3-BSJ-U 3:1

Call 800-321-7800 or visit us online at www.nookindustries.com to configure and order your G3-BSJ-U 3:1 today!

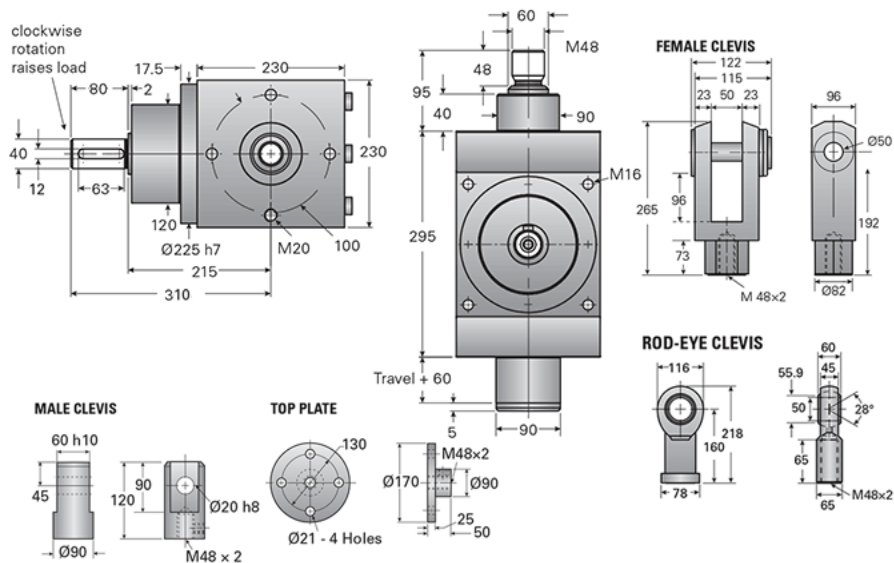

Details

| | |
|---------------------------------|-------|
| Capacity [kN] | 90 |
| Gear Ratio | 3:1 |
| Raise for One Turn of Worm [mm] | 3.33 |
| Torque to Raise 1 kN [Nm] | 0.71 |
| Tare Drag Torque [Nm] | 4.30 |
| Lifting Screw Diameter [mm] | 63 |
| Screw Lead [mm] | 10 |
| BackDrive Holding Torque [Nm] | 31.47 |

Performance Specifications

| | |
|---------------------------|------|
| Maximum Input Torque [Nm] | 1600 |
| Dynamic Load Ca [kN] | 76.0 |

Weight

| | |
|--------------------------|-------|
| Base 0 Travel [kg] | 36.30 |
| Per 100mm of Travel [kg] | 2.12 |
| Grease [kg] | 1.00 |