

MBN40x40R-8CW

Call 800-321-7800 or visit us online at www.nookindustries.com to configure and order your MBN40x40R-8CW today!

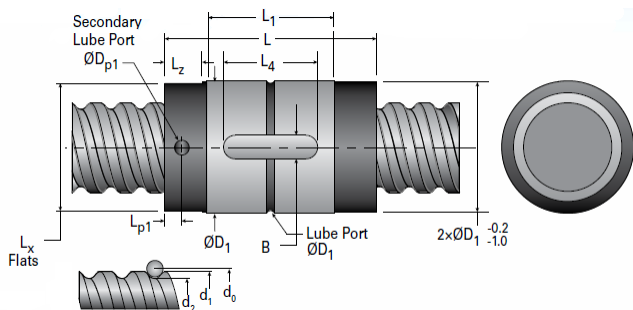

Product Info

Nominal Rod Diameter [mm]	40
Material	Alloy
Thread Direction	RH

Details

Lead [mm]	40
Active Turns	8
Nominal Ball Dia. [mm]	6.350
Screw Weight [kg/m]	8.06
Nut Weight [kg]	1.85
End Code for Types 1,2, and 3	30
End Code for Types 4	19
End Code for Types 5	25
End Code for Types 6	30
End Code for Types 7	30

Performance Specifications

Dynamic Load Ca [N]	75440
Static Load [N]	181330
Linear Speed (Based on DN Values) [mm/min]	70000

Screw Dimensions

d0 [mm]	40
d1 [mm]	38.49
d2 [mm]	33.45

Nut Dimensions

D1 (g6) [mm]	70
L1 [mm]	60
Dp [mm]	2.4
Lp1 [mm]	-
Dp1 [mm]	-
L [mm]	102
Lx [mm]	67
Lz [mm]	10
L4 [mm]	40
B (P9) [mm]	5