

## MBN32x5R-4CW

Call 800-321-7800 or visit us online at [www.nookindustries.com](http://www.nookindustries.com) to configure and order your MBN32x5R-4CW today!

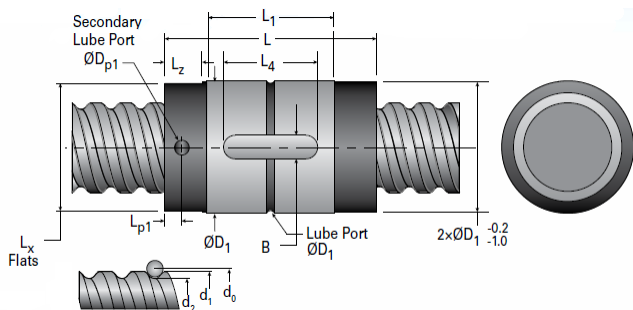

### Product Info

Nominal Rod Diameter [mm]	32
Material	Alloy
Thread Direction	RH

### Details

Lead [mm]	5
Active Turns	4
Nominal Ball Dia. [mm]	3.500
Screw Weight [kg/m]	5.48
Nut Weight [kg]	0.33
End Code for Types 1,2, and 3	25
End Code for Types 4	16
End Code for Types 5	25
End Code for Types 6	25
End Code for Types 7	25

### Performance Specifications

Dynamic Load Ca [N]	18630
Static Load [N]	43790
Linear Speed (Based on DN Values) [mm/min]	11000

### Screw Dimensions

d0 [mm]	32
d1 [mm]	31.26
d2 [mm]	28.38

### Nut Dimensions

D1 (g6) [mm]	48
L1 [mm]	28
Dp [mm]	1.5
Lp1 [mm]	-
Dp1 [mm]	-
L [mm]	48
Lx [mm]	46
Lz [mm]	8
L4 [mm]	20
B (P9) [mm]	5