

MBN20x10R-4CW

Call 800-321-7800 or visit us online at www.nookindustries.com to configure and order your MBN20x10R-4CW today!

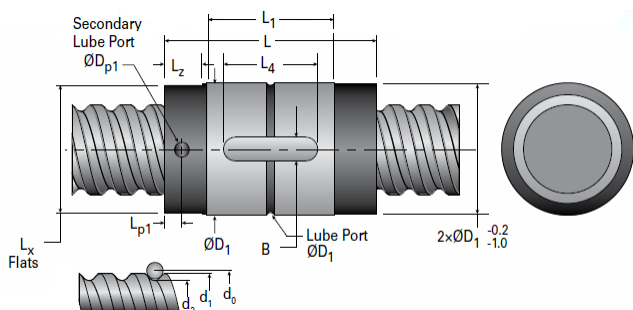

Product Info

Nominal Rod Diameter [mm]	20
Material	Alloy
Thread Direction	RH

Details

Lead [mm]	10
Active Turns	4
Nominal Ball Dia. [mm]	3.000
Screw Weight [kg/m]	2.04
Nut Weight [kg]	0.20
End Code for Types 1,2, and 3	15
End Code for Types 4	10
End Code for Types 5	15
End Code for Types 6	15
End Code for Types 7	15

Performance Specifications

Dynamic Load Ca [N]	12550
Static Load [N]	24600
Linear Speed (Based on DN Values) [mm/min]	35000

Screw Dimensions

d0 [mm]	20
d1 [mm]	18.98
d2 [mm]	16.90

Nut Dimensions

D1 (g6) [mm]	33
L1 [mm]	60
Dp [mm]	1.5
Lp1 [mm]	9.5
Dp1 [mm]	4
L [mm]	60
Lx [mm]	31
Lz [mm]	10
L4 [mm]	20
B (P9) [mm]	5