

NIA5-115-30-B

Call 800-321-7800 or visit us online at www.nookindustries.com to configure and order your NIA5-115-30-B today!

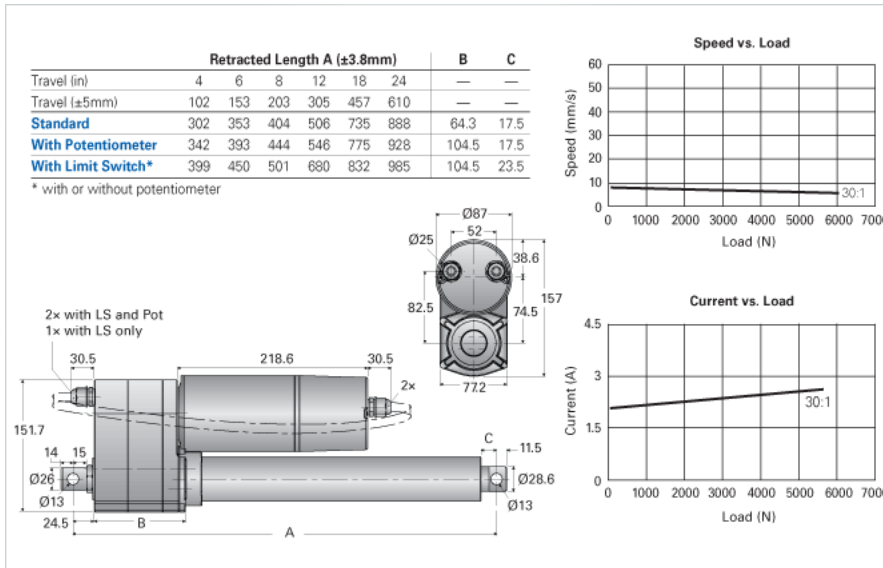

Product Info

Screw Type

Ball Screw

Details

Voltage [VAC]

115

Hertz [Hz]

60

Gear Ratio

30:1

Speed At No Load [mm/s]

7.25

Speed At Full Load [mm/s]

3.6

Load Capacity Dynamic Load [N]

6000

Load Capacity Static Load [N]

13600

Amps

2.5

Performance Specifications

Duty Cycle [% of 5 Minutes]

25

Rated Cycles At Full Load

10000

Protection Class

IP65