

## CCU28-A8 F

Call 800-321-7800 or visit us online at [www.nookindustries.com](http://www.nookindustries.com) to configure and order your CCU28-A8 F today!

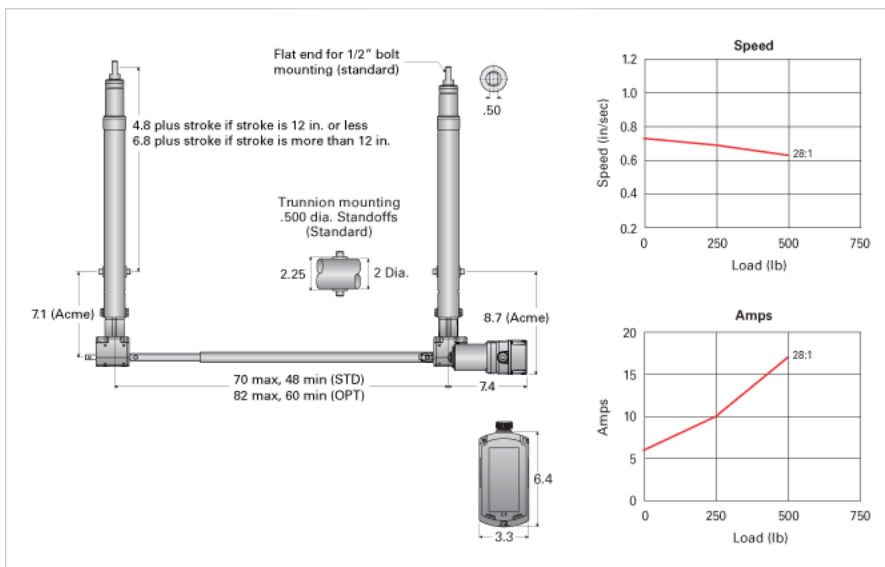

### Product Info

Screw Type

Acme Screw

### Details

Screw Size

5/8-5 RA

Voltage

12 VDC Hi Speed

Gear Ratio

28:1

Load Capacity [lb]

500

Speed [in/sec]

0.6

Amps

16

Maximum Cylinder Width [in]

70

Minimum Cylinder Width [in]

48

### Performance Specifications

Duty Cycle [% of 5 Minutes]

25

Protection Class

IP54

Maximum Temperature Range [F°]

160

Minimum Temperature Range [F°]

-30