

ELZQ 80 h6 WAC Extended Carriage

Call 800-321-7800 or visit us online at www.nookindustries.com to configure and order your ELZQ 80 h6 WAC Extended Carriage today!

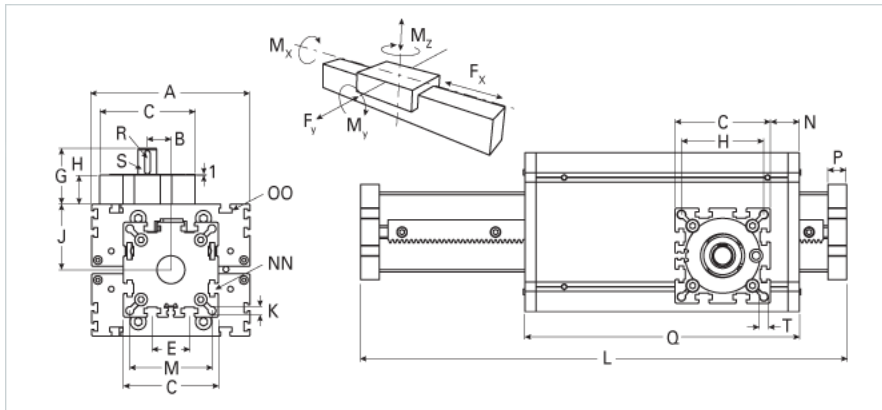
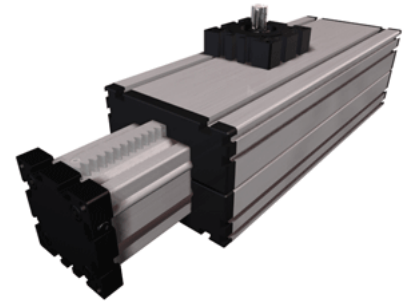

Details

Size 80

Dimensions

Basic Length L [mm]	446
A [mm]	170
B [mm]	25.5
C [mm]	102
D [mm]	80
E [mm]	40
G [mm]	60.5
H [mm]	31
J [mm]	70
K [mm]	8.8
M [mm]	88
N [mm]	25
NN	M10
OO	M10
P [mm]	20
Q [mm]	400
T	M10

Speed

Speed Maximum [m/s] 4

Forces and Torques

Fx dynamic [N]	1400
Fy dynamic [N]	2000
Fz dynamic [N]	1100
Mx dynamic [Nm]	55
My dynamic [Nm]	80
Mz dynamic [Nm]	120
Fx static [N]	1800
Fy static [N]	3000
Fz static [N]	1700
Mx static [Nm]	90
My static [Nm]	110
Mz static [Nm]	150

Geometrical moments of inertia of aluminum profile

Elastic modulus [N/mm ²]	70000
Ix [mm ⁴]	1899000
Iy [mm ⁴]	1897000

Weight

Additional Weight per 100 mm [kg]	1.19
Basic Weight [kg]	11.0