

ELZQ 60 h6 WAC Extended Carriage

Call 800-321-7800 or visit us online at www.nookindustries.com to configure and order your ELZQ 60 h6 WAC Extended Carriage today!

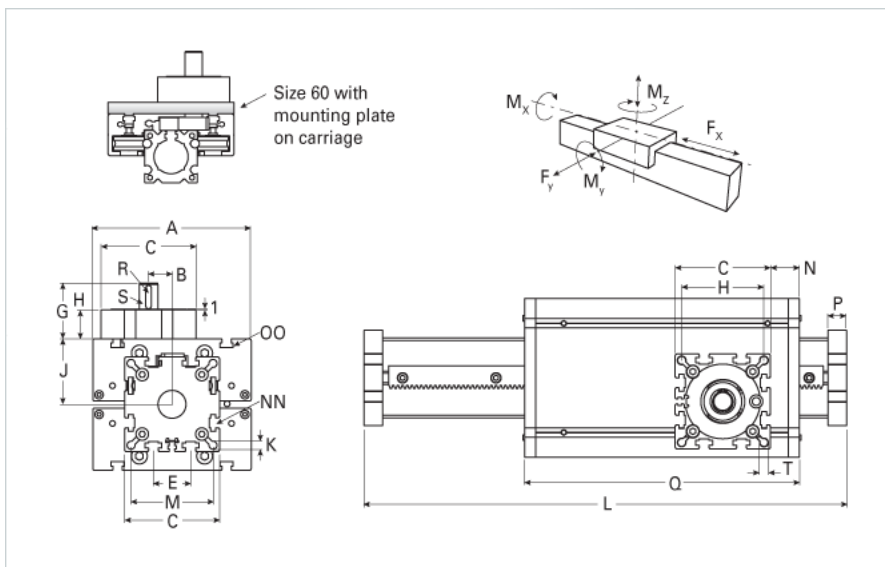
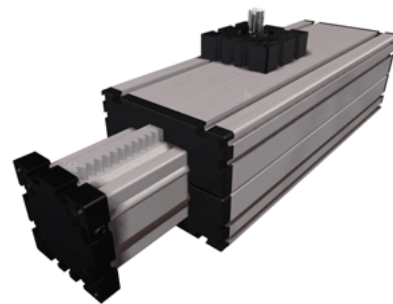

Details

Size 60

Dimensions

Basic Length L [mm]	390
A [mm]	144
B [mm]	25.5
C [mm]	82
D [mm]	62
E [mm]	30
G [mm]	71.5
H [mm]	42
J [mm]	49
K [mm]	8.5
M [mm]	69
N [mm]	32
NN	M8
OO	M8
P [mm]	16
Q [mm]	354
T	M10

Speed

Speed Maximum [m/s] 4

Forces and Torques

Fx dynamic [N]	1400
Fy dynamic [N]	2000
Fz dynamic [N]	1100
Mx dynamic [Nm]	43
My dynamic [Nm]	70
Mz dynamic [Nm]	100
Fx static [N]	1800
Fy static [N]	3000
Fz static [N]	1700
Mx static [Nm]	67
My static [Nm]	90
Mz static [Nm]	120

Geometrical moments of inertia of aluminum profile

Elastic modulus [N/mm ²]	70000
Ix [mm ⁴]	679000
Iy [mm ⁴]	697000

Weight

Additional Weight per 100 mm [kg]	0.68
Basic Weight [kg]	5.3