

## ELZQ 80 h6 Extended Carriage

Call 800-321-7800 or visit us online at [www.nookindustries.com](http://www.nookindustries.com) to configure and order your ELZQ 80 h6 Extended Carriage today!

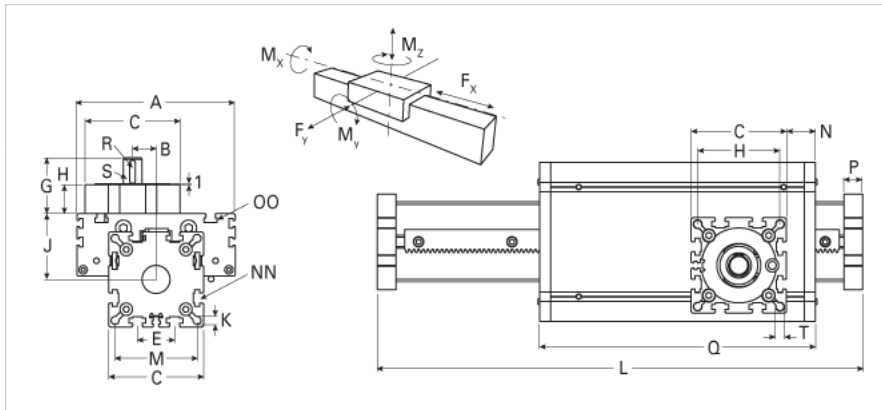
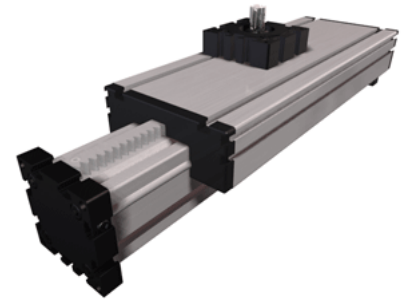

<b>Details</b>	
Size	80
<b>Dimensions</b>	
Basic Length L [mm]	430
A [mm]	170
B [mm]	25.5
C [mm]	102
D [mm]	80
E [mm]	40
G [mm]	60.5
H [mm]	31
J [mm]	70
K [mm]	8.8
M [mm]	88
N [mm]	25
NN	M10
OO	M10
P [mm]	20
Q [mm]	384
T	M10
<b>Speed</b>	
Speed Maximum [m/s]	4
<b>Forces and Torques</b>	
Fx dynamic [N]	1400
Fy dynamic [N]	2000
Fz dynamic [N]	1100
Mx dynamic [Nm]	55
My dynamic [Nm]	80
Mz dynamic [Nm]	120
Fx static [N]	1800
Fy static [N]	3000
Fz static [N]	1700
Mx static [Nm]	90
My static [Nm]	110
Mz static [Nm]	150
<b>Geometrical moments of inertia of aluminum profile</b>	
Elastic modulus [N/mm <sup>2</sup> ]	70000
Ix [mm <sup>4</sup> ]	1899000
Iy [mm <sup>4</sup> ]	1897000
<b>Weight</b>	
Additional Weight per 100 mm [kg]	1.19
Basic Weight [kg]	11.0