

## RAD-20088-A3

Call 800-321-7800 or visit us online at [www.nookindustries.com](http://www.nookindustries.com) to configure and order your RAD-20088-A3 today!

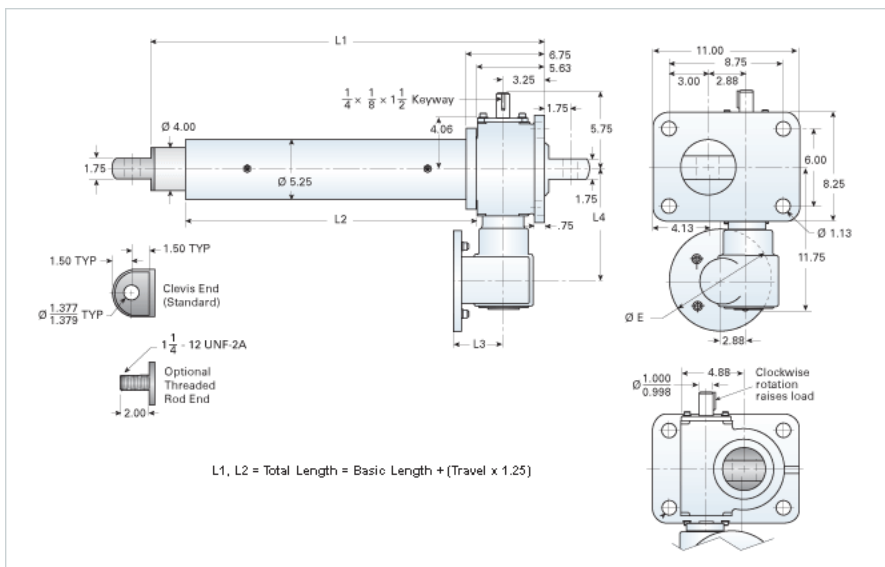

### Details

Gear Ratio Primary Reduction	8:1
Gear Ratio Secondary Reduction	8:1
Max Capacity [lb]	40000
Input Turns per Inch of Travel	192
Torque to Raise 1 lb. [in-lb]	0.0078
Acme Screw	2 1/2-3 RA
Screw Lead [in]	0.333
Root Diameter [in]	2.106
Max HP [hp]	7.5

### Weight

Basic Weight [lb]	187
Per Inch of Travel [lb]	3.60

### Tube Dimensions

L1 Basic Length [in]	17.44
L2 Basic Length [in]	8.94

### NEMA 56C Dimensions

L3 [in]	-
L4 [in]	-
E [in]	-

### NEMA 180TC Dimensions

L3 [in]	6.12
L4 [in]	9.00
F [in]	9.12