

RAD-20088-A2

Call 800-321-7800 or visit us online at www.nookindustries.com to configure and order your RAD-20088-A2 today!

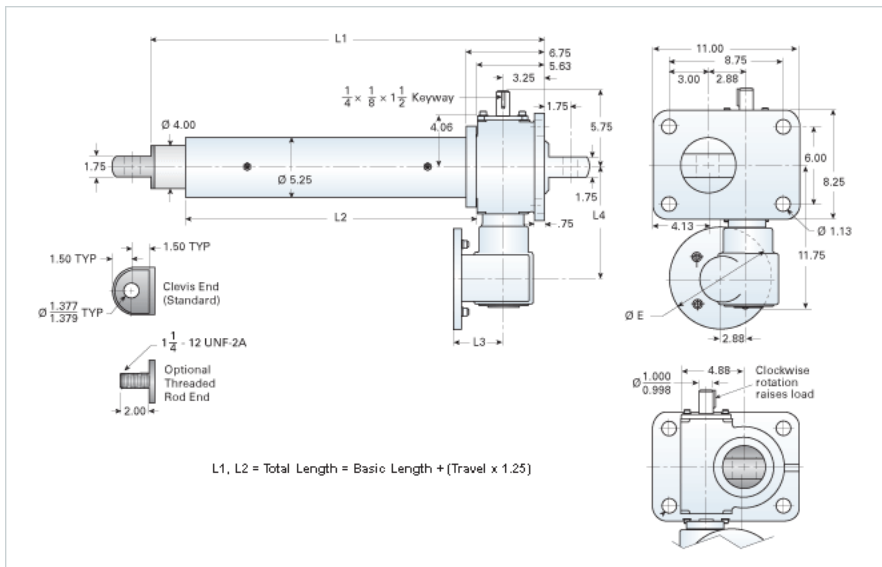

Details

Gear Ratio Primary Reduction	8:1
Gear Ratio Secondary Reduction	8:1
Max Capacity [lb]	40000
Input Turns per Inch of Travel	128
Torque to Raise 1 lb. [in-lb]	0.0086
Acme Screw	2 1/2-2 RA
Screw Lead [in]	0.500
Root Diameter [in]	1.908
Max HP [hp]	7.5

Weight

Basic Weight [lb]	187
Per Inch of Travel [lb]	3.60

Tube Dimensions

L1 Basic Length [in]	17.44
L2 Basic Length [in]	8.94

NEMA 56C Dimensions

L3 [in]	-
L4 [in]	-
E [in]	-

NEMA 180TC Dimensions

L3 [in]	6.12
L4 [in]	9.00
F [in]	9.12