

## RAD-2546-HD

Call 800-321-7800 or visit us online at [www.nookindustries.com](http://www.nookindustries.com) to configure and order your RAD-2546-HD today!

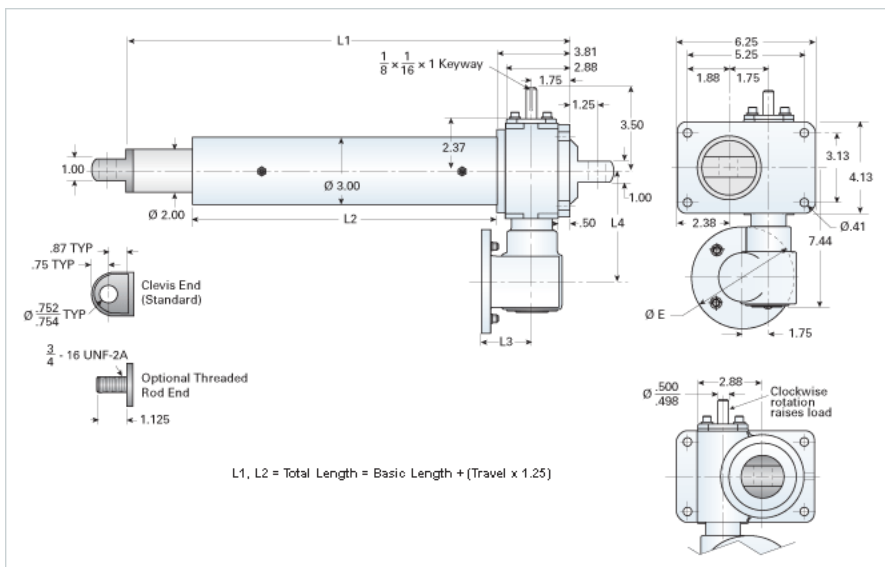

### Details

Gear Ratio Primary Reduction	24:1
Gear Ratio Secondary Reduction	6:1
Max Capacity [lb]	5000
Input Turns Per Inch Of Travel	576
Torque To Raise 1 lb. [in-lb]	0.001
Ball Screw	1000-0250 SRT RA
Screw Lead [in]	0.250
Root Diameter [in]	0.820
Max HP [hp]	0.33

### Weight

Basic Weight [lb]	46
Per Inch of Travel [lb]	1.05

### Tube Dimensions

L1 Basic Length [in]	12.44
L2 Basic Length [in]	7.13

### NEMA 56C Dimensions

L3 [in]	3.69
L4 [in]	5.63
E [in]	6.69

### NEMA 180TC Dimensions

L3 [in]	-
L4 [in]	-
F [in]	-