

QSSR 80 Extended Carriage

Call 800-321-7800 or visit us online at www.nookindustries.com to configure and order your QSSR 80 Extended Carriage today!

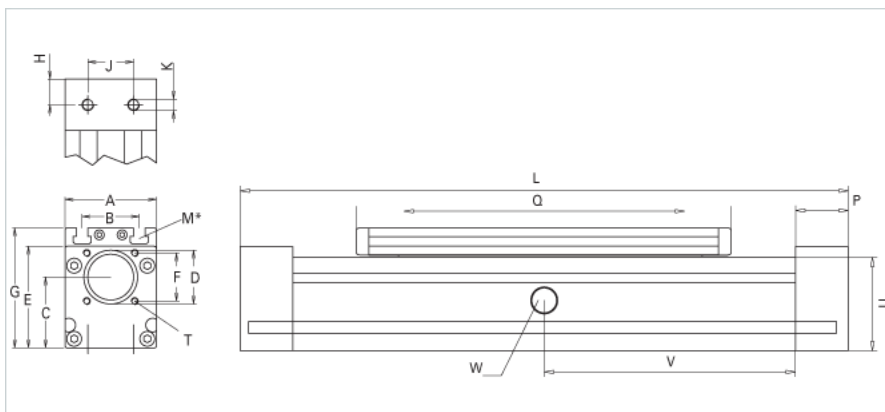
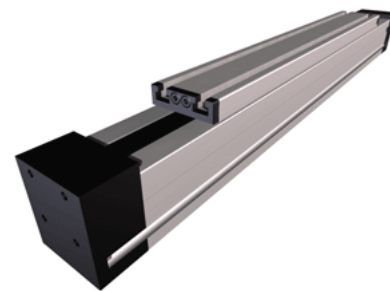

Details	
Size	80
Dimensions	
Basic Length L [mm]	436
A [mm]	80
B [mm]	50
C [mm]	62
D [mm]	47
G [mm]	106
H [mm]	22.5
J [mm]	40
K	M10
M	M8
P [mm]	45
Q [mm]	336
T	M6
U [mm]	80
Forces and Torques	
Fy [N] 10000 km	2550
Fz [N] 10000 km	6050
Mx [Nm] 10000 km	75
My [Nm] 10000 km	430
Mz [Nm] 10000 km	392
Fy [N] 5000 km	3570
Fz [N] 5000 km	8500
Mx [Nm] 5000 km	107
My [Nm] 5000 km	604
Mz [Nm] 5000 km	550
Geometrical moments of inertia of aluminum profile	
Elastic modulus [N/mm ²]	70000
Ix [mm ⁴]	1400000
Iy [mm ⁴]	1660000
Weight	
Weight Per 100 mm [kg]	0.8
Basic Weight [kg]	5.7