

DLK 160 Dual Carriage

Call 800-321-7800 or visit us online at www.nookindustries.com to configure and order your DLK 160 Dual Carriage today!

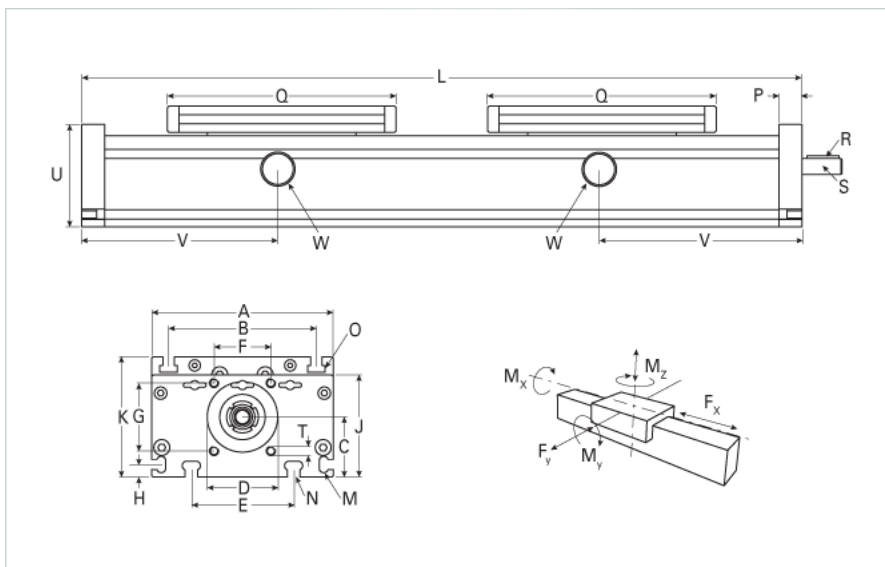
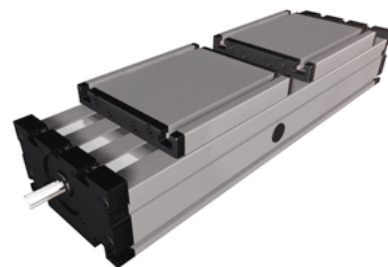

Details

Size	160
Screw Options	25x5/20x20/25x10/25x25
Screw Type	Ball Screw

Dimensions

Basic Length L [mm]	470
A [mm]	160
B [mm]	130
C [mm]	53
D [mm]	62
E [mm]	90
F [mm]	50
G [mm]	60
H [mm]	11
J [mm]	90
K [mm]	106
M	M6
N	M8
O	M8
P [mm]	20
Q [mm]	200
Shaft R Key [mm]	5x5x28
Shaft S Diameter x Length [mm]	14 h6x35
T	M8
U [mm]	80

Forces and Torques

No Load Torque-Dynamic	0.9
Fx dynamic [N]	4000
Fy dynamic [N]	2000
Fz dynamic [N]	2800
Mx dynamic [Nm]	320
My dynamic [Nm]	300
Mz dynamic [Nm]	150
Fx static [N]	5000
Fy static [N]	3000
Fz static [N]	3500
Mx static [Nm]	400
My static [Nm]	360
Mz static [Nm]	180

Geometrical moments of inertia of aluminum profile

Elastic modulus [N/mm ²]	70000
Ix [mm ⁴]	2220000
Iy [mm ⁴]	12200000

Weight

Additional Weight per 100 mm [kg]	1.96
Basic Weight [kg]	12.0