

DLR 160 Extended Carriage 6 Split Rollers

Call 800-321-7800 or visit us online at www.nookindustries.com to configure and order your DLR 160 Extended Carriage 6 Split Rollers today!

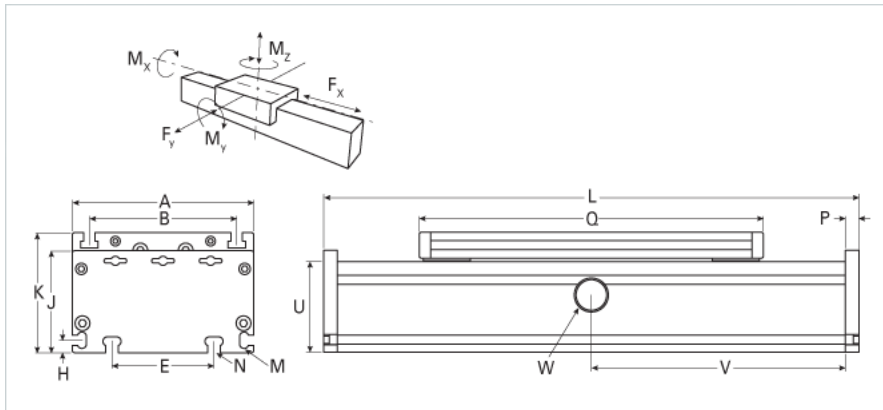

Details	
Size	160
Dimensions	
Basic Length L [mm]	340
A [mm]	160
B [mm]	130
E [mm]	90
H [mm]	11
J [mm]	90
K [mm]	106
M	M6
N	M8
O	M8
P [mm]	12
Q [mm]	300
U [mm]	80
Speed	
Speed Maximum [m/s]	6
Forces and Torques	
Fx dynamic [N]	-
Fy dynamic [N]	2000
Fz dynamic [N]	2800
Mx dynamic [Nm]	320
My dynamic [Nm]	300
Mz dynamic [Nm]	150
Fx static [N]	-
Fy static [N]	3000
Fz static [N]	3500
Mx static [Nm]	400
My static [Nm]	360
Mz static [Nm]	180
Geometrical moments of inertia of aluminum profile	
Elastic modulus [N/mm ²]	70000
Ix [mm ⁴]	2220000
Iy [mm ⁴]	12200000
Weight	
Additional Weight per 100 mm [kg] {.00}	1.42
Basic Weight [kg]	6.9