

## QLR 100 Extended Carriage 6 Split Rollers

Call 800-321-7800 or visit us online at [www.nookindustries.com](http://www.nookindustries.com) to configure and order your QLR 100 Extended Carriage 6 Split Rollers today!

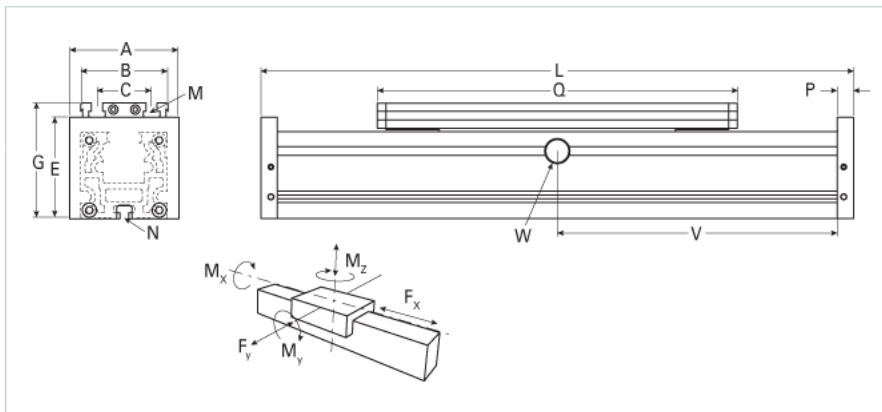

<b>Details</b>	
Size	100
<b>Dimensions</b>	
Basic Length L [mm]	430
A [mm]	130
B [mm]	100
C [mm]	66
E [mm]	110
G [mm]	129
M	M10
N	M10
P [mm]	20
Q [mm]	388
<b>Speed</b>	
Speed Maximum [m/s]	7
<b>Forces and Torques</b>	
Fx dynamic [N]	-
Fy dynamic [N]	1500
Fz dynamic [N]	1700
Mx dynamic [Nm]	60
My dynamic [Nm]	110
Mz dynamic [Nm]	90
Fx static [N]	-
Fy static [N]	1900
Fz static [N]	2100
Mx static [Nm]	85
My static [Nm]	140
Mz static [Nm]	110
<b>Geometrical moments of inertia of aluminum profile</b>	
Elastic modulus [N/mm <sup>2</sup> ]	70000
Ix [mm <sup>4</sup> ]	4300000
Iy [mm <sup>4</sup> ]	4880000
<b>Weight</b>	
Additional Weight per 100 mm [kg]	1.42
Basic Weight [kg]	7.2