

QLR 80 Extended Carriage 4 Split Rollers

Call 800-321-7800 or visit us online at www.nookindustries.com to configure and order your QLR 80 Extended Carriage 4 Split Rollers today!

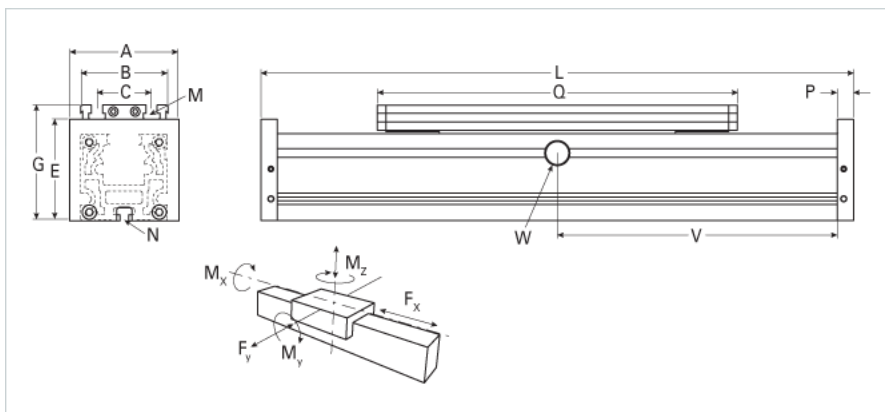

Details	
Size	80
Dimensions	
Basic Length L [mm]	340
A [mm]	100
B [mm]	80
C [mm]	50
E [mm]	93
G [mm]	106
M	M8
N	M6
P [mm]	17
Q [mm]	296
Speed	
Speed Maximum [m/s]	6
Forces and Torques	
F _x dynamic [N]	-
F _y dynamic [N]	1240
F _z dynamic [N]	1200
M _x dynamic [Nm]	40
M _y dynamic [Nm]	80
M _z dynamic [Nm]	60
F _x static [N]	-
F _y static [N]	1600
F _z static [N]	1500
M _x static [Nm]	50
M _y static [Nm]	100
M _z static [Nm]	75
Geometrical moments of inertia of aluminum profile	
Elastic modulus [N/mm ²]	70000
I _x [mm ⁴]	1650000
I _y [mm ⁴]	1870000
Weight	
Additional Weight per 100 mm [kg]	0.75
Basic Weight [kg]	4.2