

DLVZ 120 Extended Carriage 6 Split Rollers

Call 800-321-7800 or visit us online at www.nookindustries.com to configure and order your DLVZ 120 Extended Carriage 6 Split Rollers today!

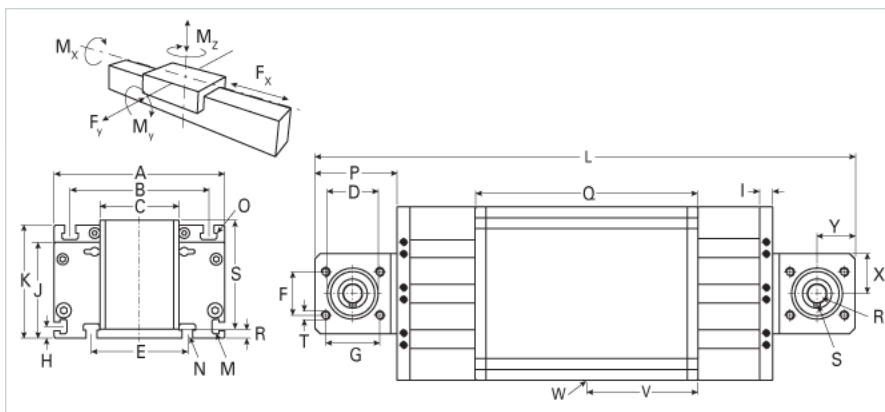
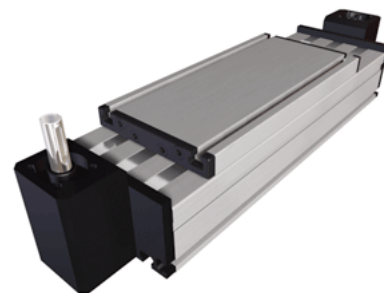

Details	
Size	120
Belt	5M25
mm/Rev	80
Number of Teeth	16
Pully Diameter [mm]	25.5
Dimensions	
Basic Length L [mm]	380
A [mm]	120
B [mm]	96
C [mm]	56
D [mm]	37
E [mm]	78
F [mm]	30
G [mm]	36
H [mm]	10
I [mm]	10
J [mm]	68
K [mm]	79
M	M5
N	M6
O	M6
P [mm]	56
Q [mm]	236
R [mm]	2.5
S [mm]	82
T	M6
U [mm]	60
X [mm]	28
Y [mm]	24
Z [mm]	14
Shaft Diameter and Length [mm]	14 x 35
Key	5x5x28
Speed	
Speed Maximum [m/s]	3
Forces and Torques	
No-load torque [Nm]	1.4
Tensile force 0.2 sec [N]	1000
Tensile force permanent [N]	900
Fx dynamic [N]	800
Fy dynamic [N]	900
Fz dynamic [N]	1000
Mx dynamic [Nm]	125
My dynamic [Nm]	120
Mz dynamic [Nm]	90
Fx static [N]	894
Fy static [N]	1100
Fz static [N]	1250
Mx static [Nm]	150
My static [Nm]	140
Mz static [Nm]	100
Geometrical moments of inertia of aluminum profile	
Elastic modulus [N/mm ²]	70000
Ix [mm ⁴]	660000

ly [mm ⁴]	3860000
Weight	
Additional Weight per 100 mm [kg]	0.82
Basic Weight [kg]	4.6