

QLZ 60 Extended Carriage

Call 800-321-7800 or visit us online at www.nookindustries.com to configure and order your QLZ 60 Extended Carriage today!

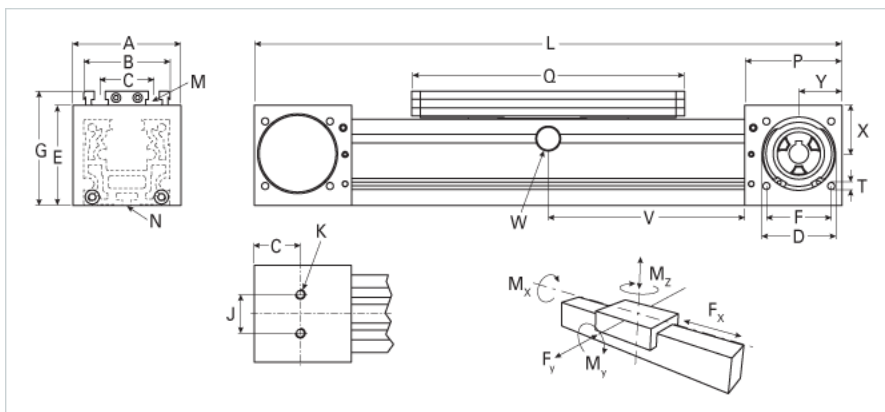
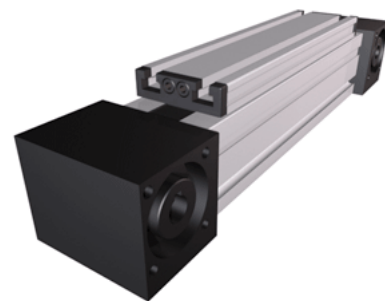

Details	
Size	60
Belt	5M25
mm/Rev	130
Number of Teeth	26
Dimensions	
Basic Length L [mm]	320
A [mm]	80
B [mm]	60
C [mm]	36
D [mm]	47
E [mm]	63
F [mm]	42
G [mm]	79
H [mm]	29.5
J [mm]	30
K	M8
M	M6
N	M5
P [mm]	59
Q [mm]	192
T	M6
X [mm]	27
Y [mm]	26
Shaft Diameter and Length [mm]	14 x 35
Key	5x5x28
Speed	
Speed Maximum [m/s]	4
Forces and Torques	
No-load torque [Nm]	0.6
Tensile force 0.2 sec [N]	1000
Tensile force permanent [N]	900
Fx dynamic [N]	800
Fy dynamic [N]	500
Fz dynamic [N]	650
Mx dynamic [Nm]	10
My dynamic [Nm]	50
Mz dynamic [Nm]	40
Fx static [N]	894
Fy static [N]	600
Fz static [N]	900
Mx static [Nm]	15
My static [Nm]	60
Mz static [Nm]	40
Geometrical moments of inertia of aluminum profile	
Elastic modulus [N/mm ²]	70000
Ix [mm ⁴]	430000
Iy [mm ⁴]	480000
Shaft Details	
Key [mm]	5x5x28
Shaft Diameter h6 x Length [mm]	14 x 35
Weight	
Additional Weight per 100 mm [kg]	0.39
Basic Weight [kg]	3.2

Values for Calculating Inertias

Pulley Material	Steel
Pulley Diameter [mm]	41.38
Effective Pulley Width [mm]	80
Belt Weight [kg/m]	0.123
Standard Carriage Weight [kg]	0.54
No-load torque [Nm]	0.6
Friction Coefficient	0.01