

ELZ 100 WAC

Call 800-321-7800 or visit us online at www.nookindustries.com to configure and order your ELZ 100 WAC today!

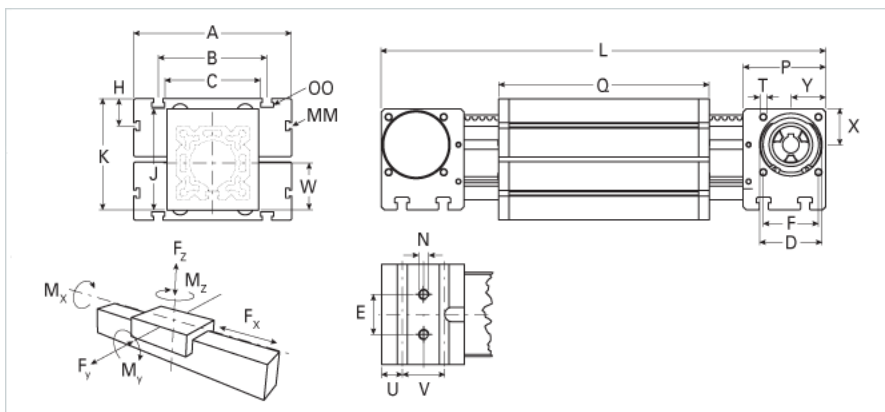
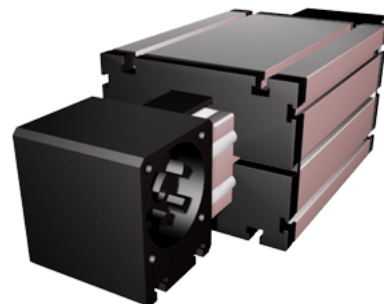

Details	
Size	100
Belt	8M50
mm/Rev	256
Number of Teeth	32
Dimensions	
Basic Length L [mm]	546
A [mm]	230
B [mm]	155
C [mm]	130
D [mm]	90
E [mm]	50
F [mm]	80
G [mm]	-
H [mm]	30
J [mm]	135
K [mm]	154
MM T-Nut	M10
N - Bolt Size	M12
OO - T-Nut	M10
P [mm]	110
Q [mm]	316
T T-Nut	M10
U [mm]	23
V [mm]	64
W [mm]	65
X [mm]	50
Y [mm]	50
Shaft Diameter and Length [mm]	22 x 45
Key	6x6x40
Speed	
Speed Maximum [m/s]	10
Forces and Torques	
No-load torque [Nm]	1.4
Tensile force 0.2 sec [N]	4300
Tensile force permanent [N]	4000
Fx dynamic [N]	3800
Fy dynamic [N]	6500
Fz dynamic [N]	2200
Mx dynamic [Nm]	230
My dynamic [Nm]	270
Mz dynamic [Nm]	500
Fx static [N]	4000
Fy static [N]	8000
Fz static [N]	3600
Mx static [Nm]	300
My static [Nm]	400
Mz static [Nm]	750
Geometrical moments of inertia of aluminum profile	
Elastic modulus [N/mm ²]	70000
Ix [mm ⁴]	4440000
Iy [mm ⁴]	4480000
Weight	
Additional Weight per 100 mm [kg]	1.60

Basic Weight [kg]	24.0
Values for Calculating Inertias	
Pulley Material	Aluminum
Pulley Diameter [mm]	81.49
Effective Pulley Width [mm]	130.0
Belt Weight [kg/m]	0.355
Standard Carriage Weight [kg]	13.10
No-load torque [Nm]	1.4
Friction Coefficient	0.01