

## NH35TA Assembly

Call 800-321-7800 or visit us online at [www.nookindustries.com](http://www.nookindustries.com) to configure and order your NH35TA Assembly today!

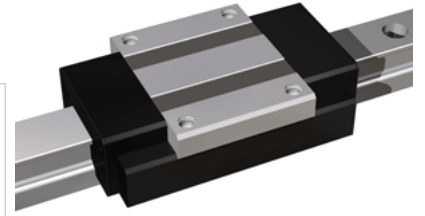
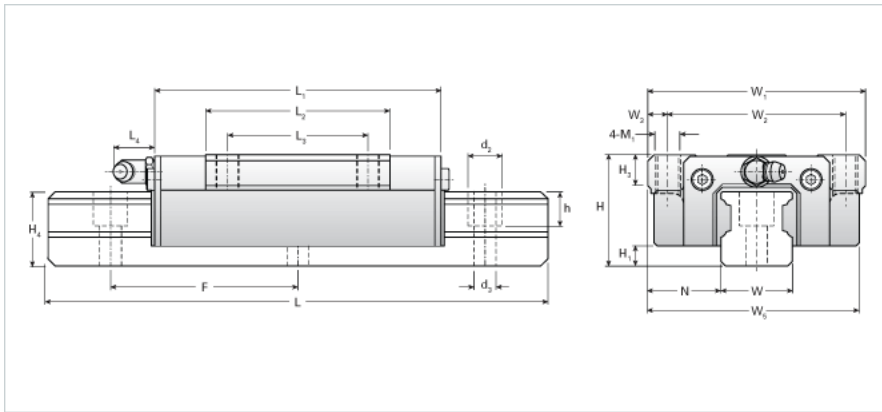

<b>Dimensions</b>	
H [mm]	48
H1 [mm]	8
N [mm]	33.0
<b>Metric Profile Rail (Rail)Details</b>	
Size [mm]	35
Type	Standard
<b>(Rail)Dimensions</b>	
d2 [mm]	14
d3 [mm]	9
h [mm]	15
H4 [mm]	32
F [mm]	80
W [mm]	34
Maximum Length [mm]	4000
<b>(Rail)Weight</b>	
Weights-Rail [kg/m]	7.5
<b>Metric Runner Block, Heavy Load, High Speed, 4 Tapped Holes On Flange (Runner Block)Details</b>	
Size [mm]	35
<b>(Runner Block)Dimensions</b>	
L1 [mm]	128
L2 [mm]	80
L3 [mm]	62
L4 [mm]	12
M1 x l	M10X16
H3 [mm]	13
W1 [mm]	100
W2 [mm]	82
W3 [mm]	9
W5 [mm]	92
<b>(Runner Block)Forces and Torques</b>	
Basic Load Ratings C [kN]	37.55
Basic Load Ratings C [lbf]	8441
Basic Load Ratings C0 [kN]	62.55
Basic Load Ratings C0 [lbf]	14061
Static Moment Ratings-Ma [kN-m]	0.64
Static Moment Ratings-Ma [lb-in]	5642
Static Moment Ratings-Mb [kN-m]	0.64
Static Moment Ratings-Mb [lb-in]	5642
Static Moment Ratings-Mc [kN-m]	1.13
Static Moment Ratings-Mc [lb-in]	9982
<b>(Runner Block)Weight</b>	
Weight-Block [kg]	1.5
<b>(Runner Block)Grease Fitting</b>	
Grease Fitting Part Number	B-M6F