

## Type 5N, End Code 75

Call 800-321-7800 or visit us online at [www.nookindustries.com](http://www.nookindustries.com) to configure and order your Type 5N, End Code 75 today!

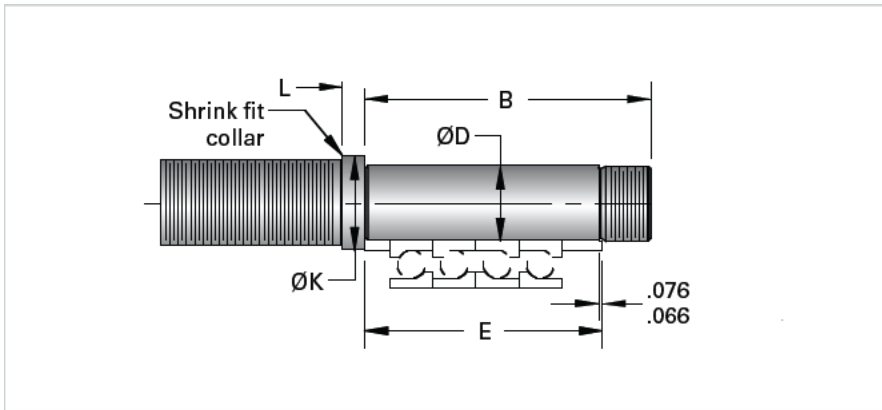

### Product Info

Nominal Bearing Journal Size [mm] 75

### Dimensions

B [mm]	232
D Maximum [mm]	75.012
D Minimum [mm]	74.993
E [mm]	198
K [mm]	90
L [mm]	18
Lock Nut	SFZ 75X2