

## Type 5N, End Code 35

Call 800-321-7800 or visit us online at [www.nookindustries.com](http://www.nookindustries.com) to configure and order your Type 5N, End Code 35 today!

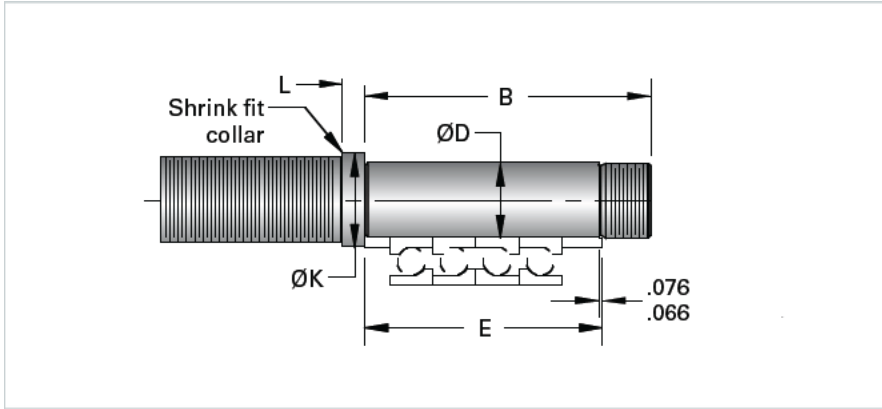

### Product Info

Nominal Bearing Journal Size [mm]

35

### Dimensions

B [mm]

143

D Maximum [mm]

35.011

D Minimum [mm]

34.995

E [mm]

117

K [mm]

45

L [mm]

10

Lock Nut

SFZ 35X1.5