

Type 5N, End Code 20

Call 800-321-7800 or visit us online at www.nookindustries.com to configure and order your Type 5N, End Code 20 today!

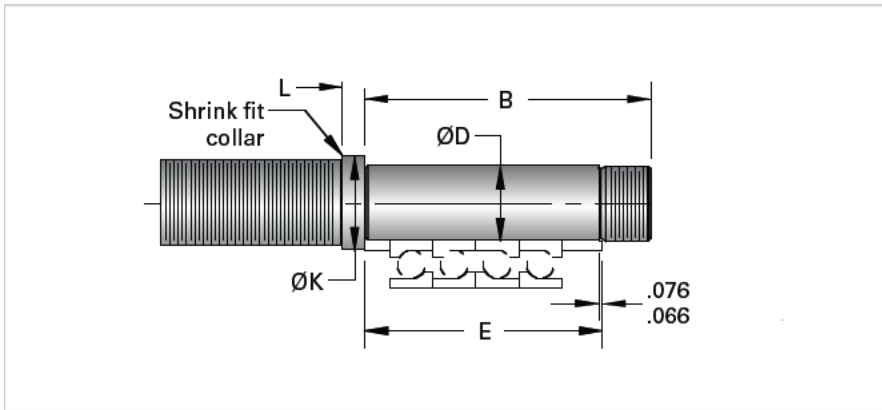

Product Info

Nominal Bearing Journal Size [mm] 20

Dimensions

B [mm]	105
D Maximum [mm]	20.009
D Minimum [mm]	19.996
E [mm]	84
K [mm]	28
L [mm]	9
Lock Nut	SFZ 20X1