

## Type 5N, End Code 17

Call 800-321-7800 or visit us online at [www.nookindustries.com](http://www.nookindustries.com) to configure and order your Type 5N, End Code 17 today!

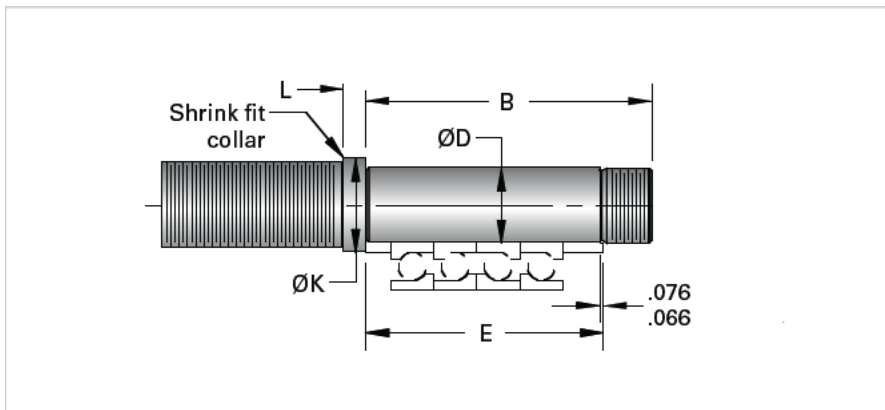

### Product Info

Nominal Bearing Journal Size [mm] 17

### Dimensions

B [mm]	79
D Maximum [mm]	17.008
D Minimum [mm]	16.997
E [mm]	80
K [mm]	24
L [mm]	9
Lock Nut	SFZ 17X1