

## Type 5N, End Code 12

Call 800-321-7800 or visit us online at [www.nookindustries.com](http://www.nookindustries.com) to configure and order your Type 5N, End Code 12 today!

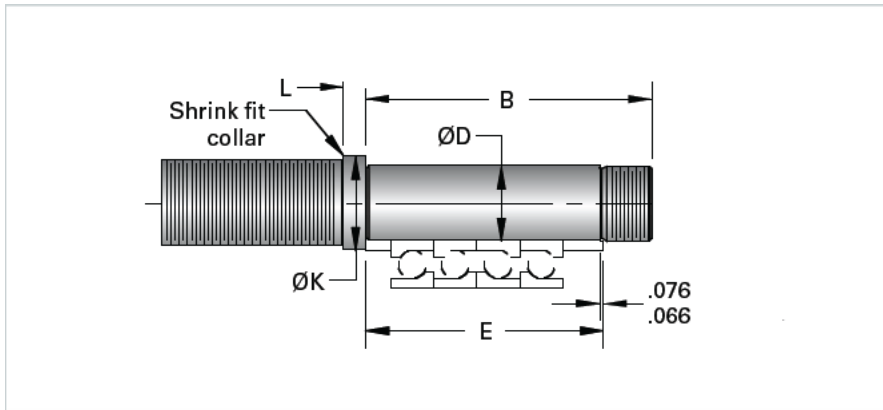

### Product Info

Nominal Bearing Journal Size [mm] 12

### Dimensions

B [mm]	85
D Maximum [mm]	12.008
D Minimum [mm]	11.997
E [mm]	69
K [mm]	18
L [mm]	8
Lock Nut	SFZ 12X1