

## Type 5L, End Code 60

Call 800-321-7800 or visit us online at [www.nookindustries.com](http://www.nookindustries.com) to configure and order your Type 5L, End Code 60 today!

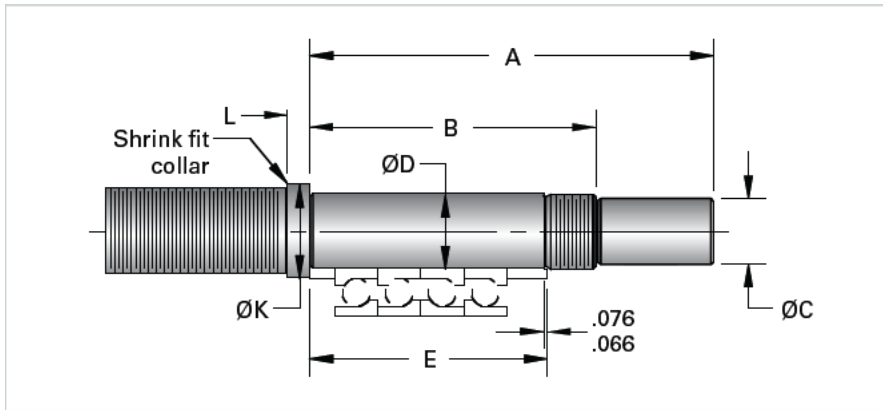

### Product Info

Nominal Bearing Journal Size [mm] 60

### Dimensions

A [mm]	291
B [mm]	202
C Maximum [mm]	55.00
C Minimum [mm]	54.97
D Maximum [mm]	60.012
D Minimum [mm]	59.993
E [mm]	171
K [mm]	75
L [mm]	16
Lock Nut	SFZ 60X2