

## Type 5L, End Code 15

Call 800-321-7800 or visit us online at [www.nookindustries.com](http://www.nookindustries.com) to configure and order your Type 5L, End Code 15 today!

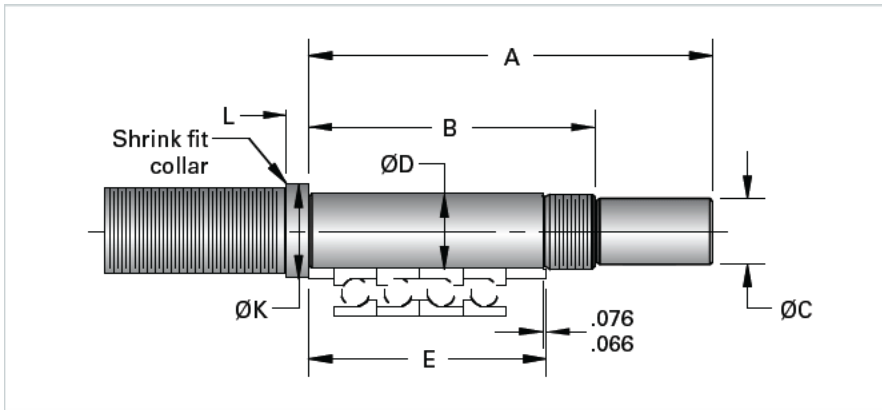

### Product Info

Nominal Bearing Journal Size [mm] 15

### Dimensions

A [mm]	133
B [mm]	93
C Maximum [mm]	12.00
C Minimum [mm]	11.97
D Maximum [mm]	15.008
D Minimum [mm]	14.997
E [mm]	74
K [mm]	22
L [mm]	9
Lock Nut	SFZ 15X1