

Type 5K, End Code 70

Call 800-321-7800 or visit us online at www.nookindustries.com to configure and order your Type 5K, End Code 70 today!

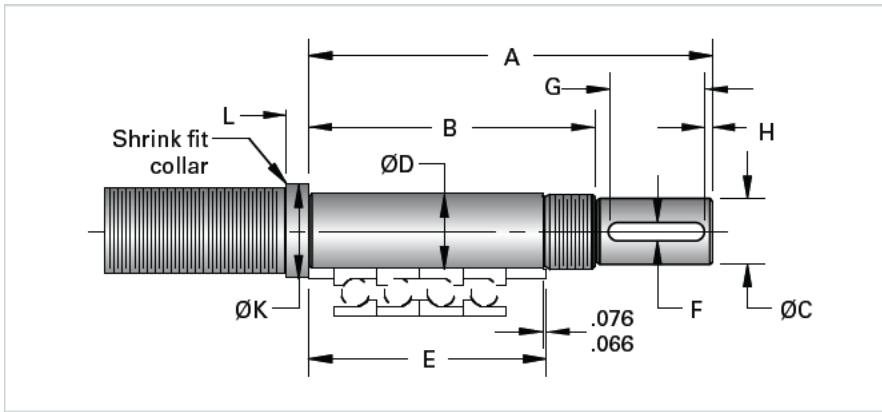

Product Info

Nominal Bearing Journal Size [mm] 70

Dimensions

| | |
|----------------|----------|
| A [mm] | 334 |
| B [mm] | 222 |
| C Maximum [mm] | 60 |
| C Minimum [mm] | 59.97 |
| D Maximum [mm] | 70.012 |
| D Minimum [mm] | 69.993 |
| E [mm] | 188 |
| F [mm] | 18 |
| G [mm] | 91 |
| H [mm] | 7 |
| K [mm] | 85 |
| L [mm] | 18 |
| Lock Nut | SFZ 70X2 |