

Type 5K, End Code 15

Call 800-321-7800 or visit us online at www.nookindustries.com to configure and order your Type 5K, End Code 15 today!

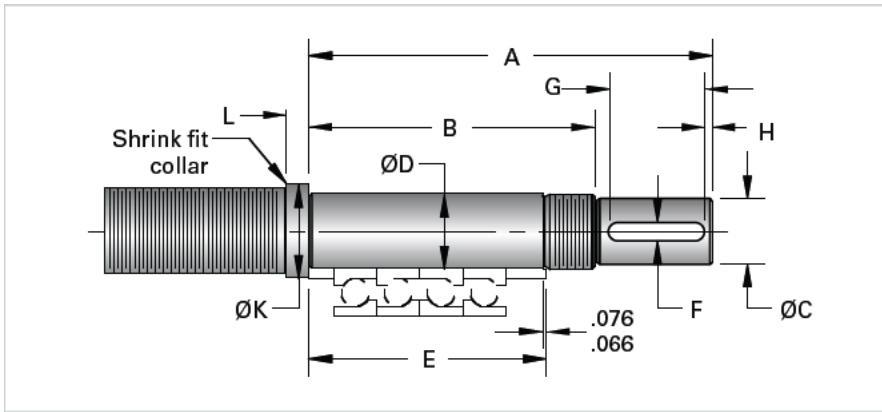

Product Info

Nominal Bearing Journal Size [mm] 15

Dimensions

A [mm]	133
B [mm]	93
C Maximum [mm]	12
C Minimum [mm]	11.97
D Maximum [mm]	45.008
D Minimum [mm]	14.997
E [mm]	74
F [mm]	4
G [mm]	33
H [mm]	3
K [mm]	22
L [mm]	9
Lock Nut	SFZ 15X1