

EZZE-MOUNT EZM-4025

Call 800-321-7800 or visit us online at www.nookindustries.com to configure and order your EZZE-MOUNT EZM-4025 today!

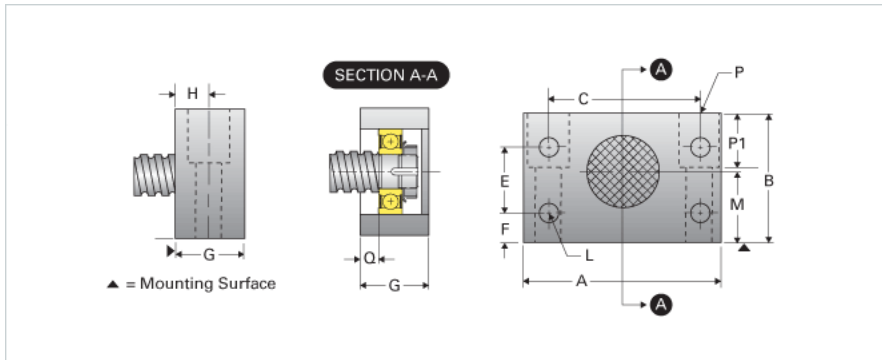
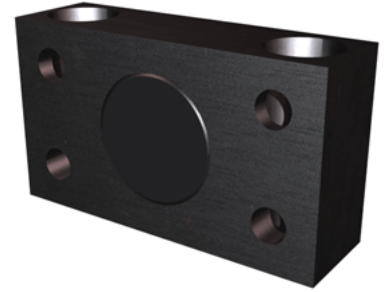

Product Info

Part Number	EZM-4025
Machined End Code	25
Nominal Bearing Journal Size [mm]	25

Dimensions

A [in]	6.50
B [in]	3.69
C [in]	4.75
E [in]	2.00
F [in]	0.88
G [in]	1.94
H [in]	0.97
L Holes [Number of Holes]	4
L Thru [in]	0.66
M [in]	1.875
P C'Bore [in]	1.38
P P1 [in]	1.75
Q [in]	0.52
P - Bolt Size (2 or 4)	7/8 x3 1/4(2)
P-Thru [in]	0.91

Weight

Weight [lb]	8.50
-------------	------