

EZZE-MOUNT EZM-3045

Call 800-321-7800 or visit us online at www.nookindustries.com to configure and order your EZZE-MOUNT EZM-3045 today!

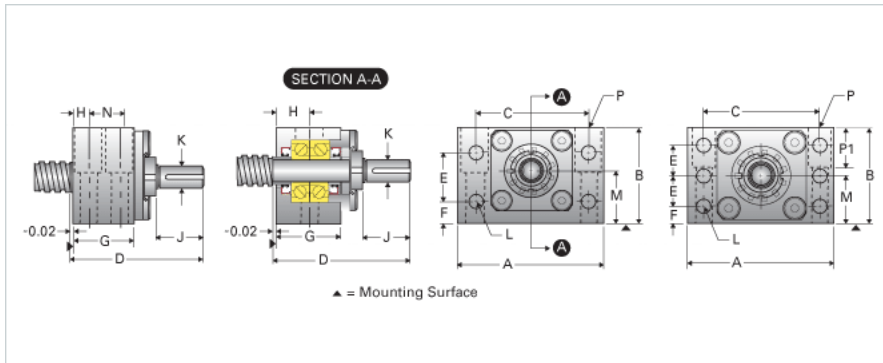
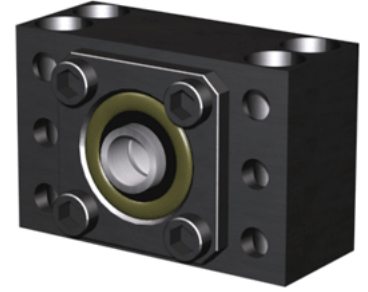

Product Info

Part Number	EZM-3045
Machined End Code	45
Nominal Bearing Journal Size [mm]	45

Dimensions

A [in]	8.50
B [in]	5.62
C [in]	6.62
D [in]	6.68
E [in]	1.81
F [in]	1.00
G [in]	3.47
H [in]	0.88
J [in]	2.19
K Shaft Diameter Maximum [in]	1.375
K Shaft Diameter Minimum [in]	1.374
L Holes [Number of Holes]	6
L Thru [in]	0.81
M [in]	2.812
N [in]	1.71
P C'Bore [in]	1.56
P P1 [in]	2.13
Q [in]	0.98
P - Bolt Size (2 or 4)	1 x 5(4)
P-Thru [in]	1.03

Weight

Weight [lb]	35.75
-------------	-------