

## EZZE-MOUNT EZM-3025

Call 800-321-7800 or visit us online at [www.nookindustries.com](http://www.nookindustries.com) to configure and order your EZZE-MOUNT EZM-3025 today!

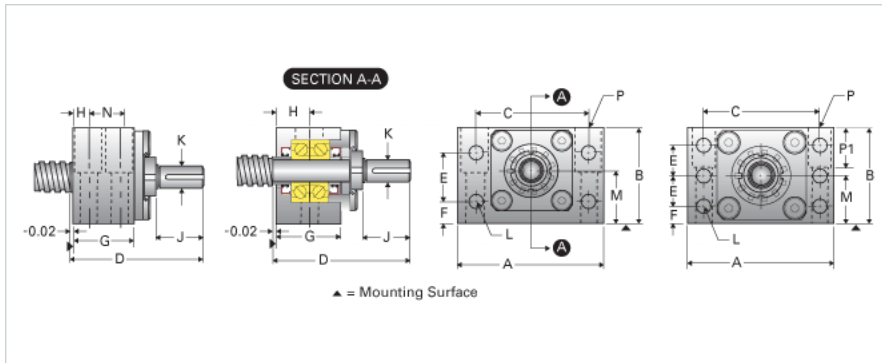
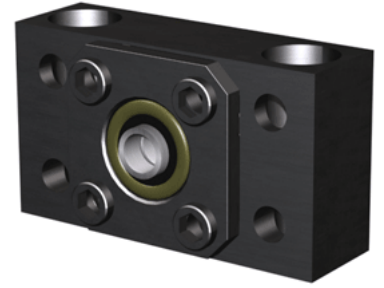

### Product Info

Part Number	EZM-3025
Machined End Code	25
Nominal Bearing Journal Size [mm]	25

### Dimensions

A [in]	6.50
B [in]	3.69
C [in]	4.75
D [in]	4.45
E [in]	2.00
F [in]	0.88
G [in]	1.94
H [in]	0.97
J [in]	1.61
K Shaft Diameter Maximum [in]	0.750
K Shaft Diameter Minimum [in]	0.749
L Holes [Number of Holes]	4
L Thru [in]	0.66
M [in]	1.875
N [in]	-
P C'Bore [in]	1.38
P P1 [in]	1.75
Q [in]	0.52
P - Bolt Size (2 or 4)	7/8 x3 1/4(2)
P-Thru [in]	0.91

### Weight

Weight [lb]	10.54
-------------	-------