

EZZE-MOUNT EZM-2020

Call 800-321-7800 or visit us online at www.nookindustries.com to configure and order your EZZE-MOUNT EZM-2020 today!

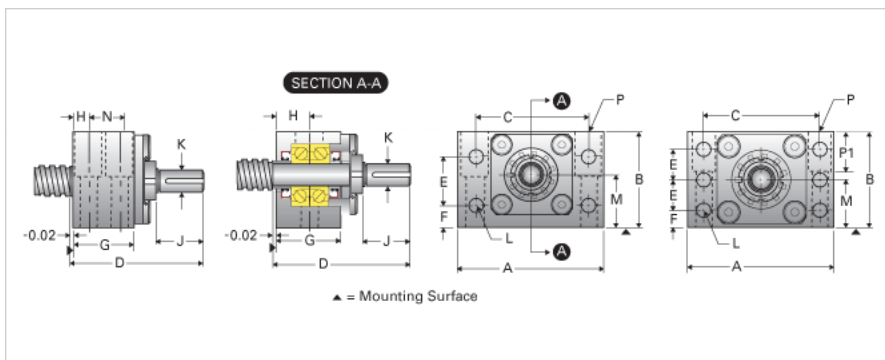
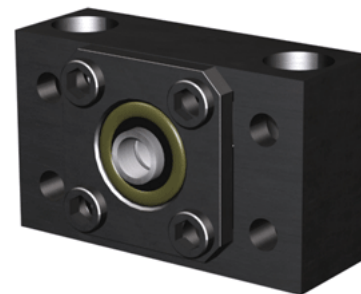

Product Info

Part Number	EZM-2020
Machined End Code	20
Nominal Bearing Journal Size [mm]	20

Dimensions

A [in]	5.00
B [in]	3.03
C [in]	3.75
D [in]	4.03
E [in]	1.50
F [in]	0.75
G [in]	1.72
H [in]	0.86
J [in]	1.30
K Shaft Diameter Maximum [in]	0.625
K Shaft Diameter Minimum [in]	0.624
L Holes [Number of Holes]	4
L Thru [in]	0.47
M [in]	1.625
N [in]	-
P C'Bore [in]	1.00
P P1 [in]	1.50
Q [in]	0.55
P - Bolt Size (2 or 4)	5/8 x2 1/2(2)
P-Thru [in]	0.66

Weight

Weight [lb]	6.22
-------------	------