

## EZZE-MOUNT EZM-3017

Call 800-321-7800 or visit us online at [www.nookindustries.com](http://www.nookindustries.com) to configure and order your EZZE-MOUNT EZM-3017 today!

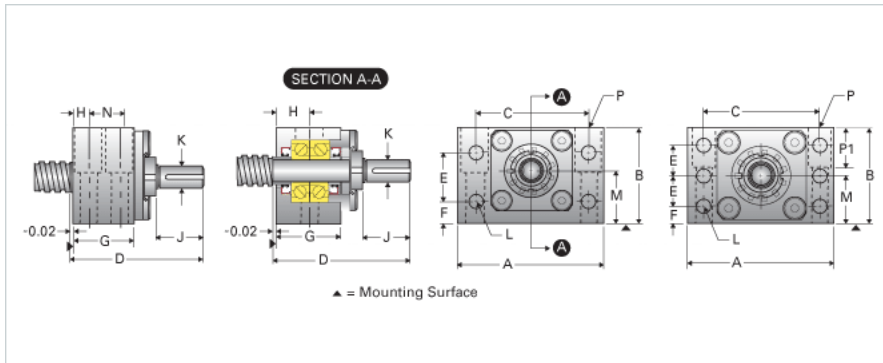

### Product Info

Part Number	EZM-3017
Machined End Code	17
Nominal Bearing Journal Size [mm]	17

### Dimensions

A [in]	4.50
B [in]	2.69
C [in]	3.38
D [in]	3.65
E [in]	1.38
F [in]	0.62
G [in]	1.69
H [in]	0.84
J [in]	1.30
K Shaft Diameter Maximum [in]	0.500
K Shaft Diameter Minimum [in]	0.499
L Holes [Number of Holes]	4
L Thru [in]	0.41
M [in]	1.500
N [in]	-
P C'Bore [in]	0.88
P P1 [in]	1.25
Q [in]	0.38
P - Bolt Size (2 or 4)	1/2 x2 1/4(2)
P-Thru [in]	0.53

### Weight

Weight [lb]	4.86
-------------	------