

EZZE-MOUNT EZM-3012

Call 800-321-7800 or visit us online at www.nookindustries.com to configure and order your EZZE-MOUNT EZM-3012 today!

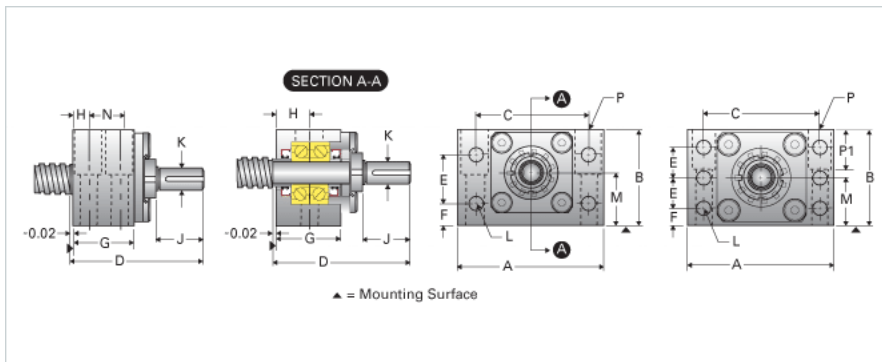

Product Info

Part Number	EZM-3012
Machined End Code	12
Nominal Bearing Journal Size [mm]	12

Dimensions

A [in]	3.50
B [in]	2.22
C [in]	2.75
D [in]	3.29
E [in]	1.25
F [in]	0.50
G [in]	1.38
H [in]	0.69
J [in]	1.30
K Shaft Diameter Maximum [in]	0.406
K Shaft Diameter Minimum [in]	0.405
L Holes [Number of Holes]	4
L Thru [in]	0.28
M [in]	1.187
N [in]	-
P C'Bore [in]	0.62
P P1 [in]	1.00
Q [in]	0.33
P - Bolt Size (2 or 4)	3/8 x 1 3/4(2)
P-Thru [in]	0.41

Weight

Weight [lb]	2.60
-------------	------