

## EZZE-MOUNT EZM-3015-34

Call 800-321-7800 or visit us online at [www.nookindustries.com](http://www.nookindustries.com) to configure and order your EZZE-MOUNT EZM-3015-34 today!

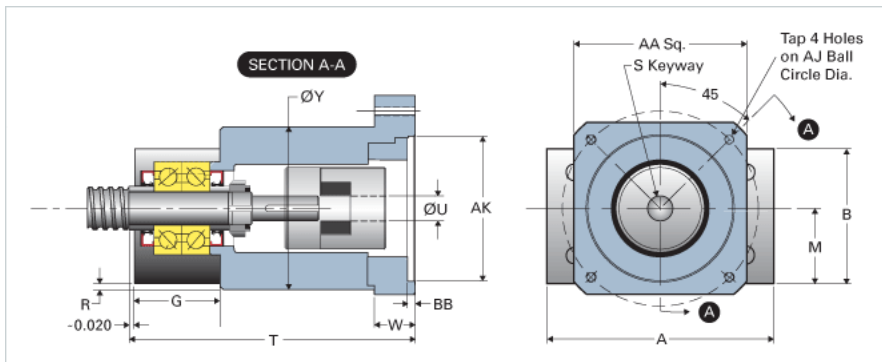

### Product Info

Part Number	EZM-3015-34
Reference Code	U3
Machined End Code	15
Nema Frame Reference	34
Nominal Bearing Journal Size [mm]	15

### Dimensions

A [in]	3.50
AA [in]	3.25
AJ [in]	3.875
AK Maximum [in]	2.882
AK Minimum [in]	2.878
B [in]	2.52
BB [in]	0.16
[in]	2.75
D [in]	3.50
E [in]	1.25
F [in]	0.80
G [in]	1.38
H [in]	0.69
J [in]	1.30
K Shaft Diameter Maximum [in]	0.500
K Shaft Diameter Minimum [in]	0.499
L Holes [Number of Holes]	4
L Thru [in]	0.028
M [in]	1.438
N	-
Q [in]	0.33
R [in]	0.19
S [in]	0.125
T [in]	5.13
U [in]	0.50
W [in]	0.81
Y [in]	2.50
P - Bolt Count	2
P - Bolt Size	3/8 x 2 1/8
P - C'Bore [in]	0.62
P - P1 [in]	1.00
P - Thru [in]	0.41
TAP	#10-32