

## EZZE-MOUNT EZM-1008-17

Call 800-321-7800 or visit us online at [www.nookindustries.com](http://www.nookindustries.com) to configure and order your EZZE-MOUNT EZM-1008-17 today!

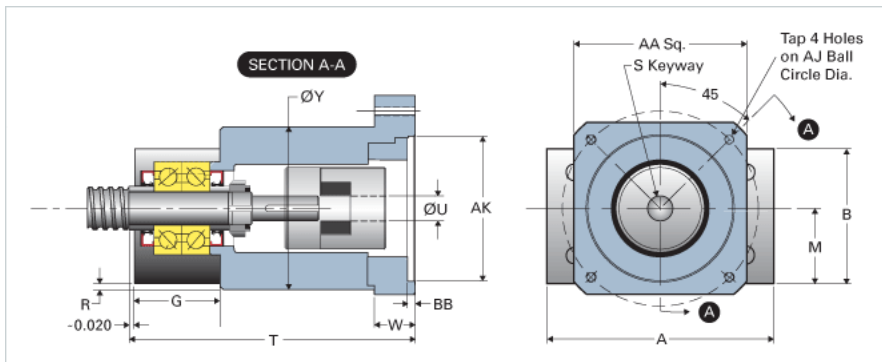
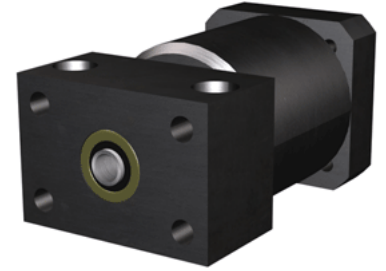

### Product Info

Part Number	EZM-1008-17
Reference Code	U1
Machined End Code	8
Nema Frame Reference	17
Nominal Bearing Journal Size [mm]	8

### Dimensions

A [in]	2.00
AA [in]	1.75
AJ [in]	1.725
AK Maximum [in]	0.871
AK Minimum [in]	0.868
B [in]	1.38
BB [in]	0.25
[in]	1.50
D [in]	2.00
E [in]	0.88
F [in]	0.25
G [in]	1.06
H [in]	0.50
J [in]	0.56
K Shaft Diameter Maximum [in]	0.250
K Shaft Diameter Minimum [in]	0.249
L Holes [Number of Holes]	4
L Thru [in]	0.220
M [in]	0.687
N	-
Q [in]	0.19
R [in]	0.19
S [in]	0.094
T [in]	3.35
U [in]	0.25
W [in]	0.52
Y [in]	1.75
P - Bolt Count	2
P - Bolt Size	1/4 x 1 3/8
P - C'Bore [in]	0.41
P - P1 [in]	0.41
P - Thru [in]	0.28
TAP	#8-32