

EZZE-MOUNT EZF-4008

Call 800-321-7800 or visit us online at www.nookindustries.com to configure and order your EZZE-MOUNT EZF-4008 today!

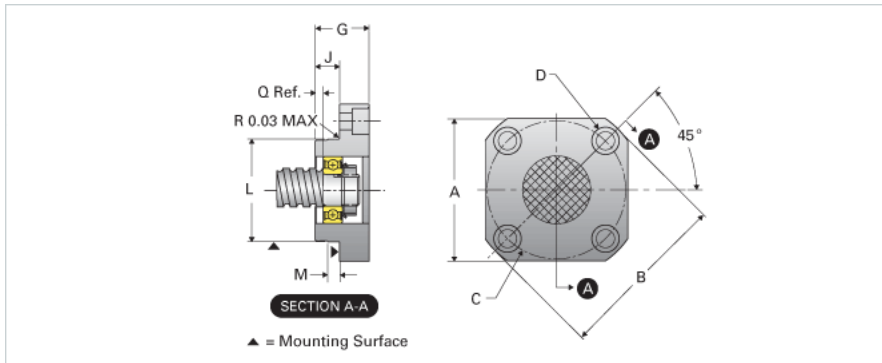
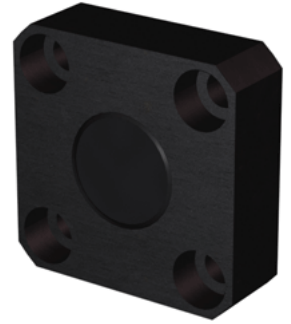

Product Info

Part Number	EZF-4008
Machined End Code	8
Nominal Bearing Journal Size [mm]	8

Dimensions

A [in]	1.88
B - Diameter [in]	2.44
C Bolt Circle [in]	1.875
C'Bore [in]	0.44
D Thru [in]	0.266
G [in]	1.00
J [in]	0.40
L Maximum [in]	1.3775
L Minimum [in]	1.3770
M [in]	0.188
Q [in]	0.13

Weight

Weight [lb]	0.50
-------------	------