

## EZZE-MOUNT EZF-2030

Call 800-321-7800 or visit us online at [www.nookindustries.com](http://www.nookindustries.com) to configure and order your EZZE-MOUNT EZF-2030 today!

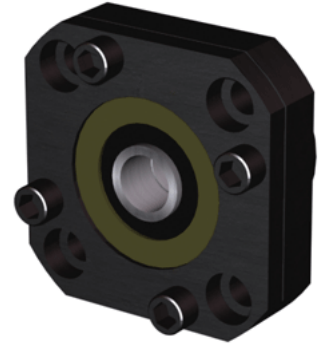

### Product Info

Part Number	EZF-2030
Machined End Code	30
Nominal Bearing Journal Size [mm]	30

### Dimensions

A [in]	4.38
B - Diameter [in]	5.31
C Bolt Circle [in]	4.25
C'Bore [in]	0.81
D Thru [in]	0.531
E [in]	4.86
F [in]	3.05
G [in]	2.36
H [in]	1.94
J [in]	1.19
K Shaft Diameter Maximum [in]	1.000
K Shaft Diameter Minimum [in]	0.999
L Minimum [in]	3.1482
L Maximum [in]	3.1492
M [in]	0.375
P [in]	0.250
Q [in]	0.25

### Weight

Weight [lb]	6.66
-------------	------