

EZZE-MOUNT EZF-2020

Call 800-321-7800 or visit us online at www.nookindustries.com to configure and order your EZZE-MOUNT EZF-2020 today!

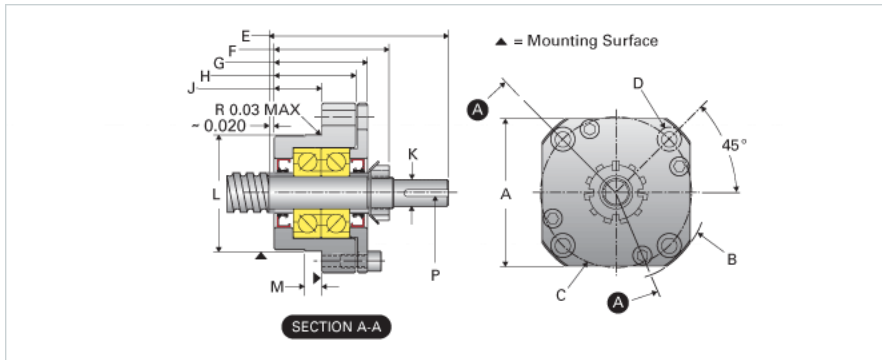
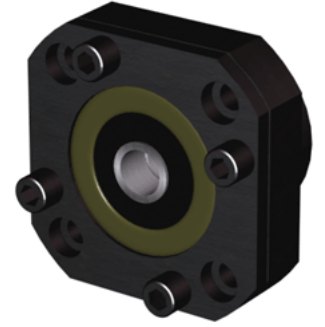

Product Info

Part Number	EZF-2020
Machined End Code	20
Nominal Bearing Journal Size [mm]	20

Dimensions

A [in]	3.38
B - Diameter [in]	4.03
C Bolt Circle [in]	3.25
C'Bore [in]	0.53
D Thru [in]	0.344
E [in]	4.03
F [in]	2.71
G [in]	1.98
H [in]	1.72
J [in]	1.03
K Shaft Diameter Maximum [in]	0.625
K Shaft Diameter Minimum [in]	0.624
L Minimum [in]	2.5185
L Maximum [in]	2.5193
M [in]	0.312
P [in]	0.188
Q [in]	0.20

Weight

Weight [lb]	3.66
-------------	------