

## EZZE-MOUNT EZF-3017

Call 800-321-7800 or visit us online at [www.nookindustries.com](http://www.nookindustries.com) to configure and order your EZZE-MOUNT EZF-3017 today!

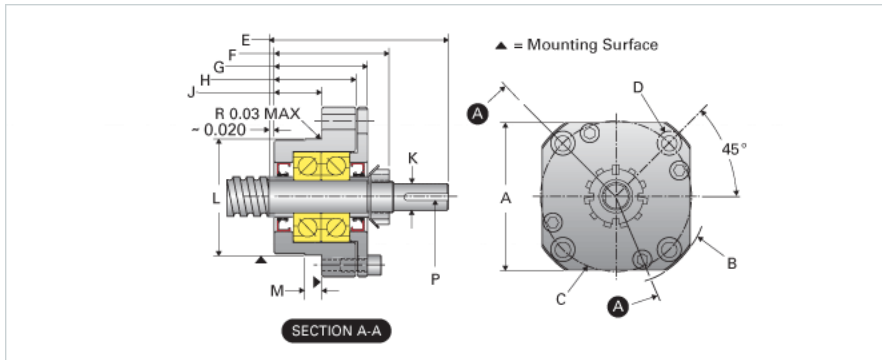
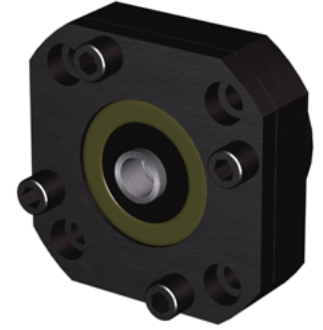

### Product Info

Part Number	EZF-3017
Machined End Code	17
Nominal Bearing Journal Size [mm]	17

### Dimensions

A [in]	3.38
B - Diameter [in]	4.03
C Bolt Circle [in]	3.25
C'Bore [in]	0.53
D Thru [in]	0.344
E [in]	3.65
F [in]	2.33
G [in]	1.93
H [in]	1.63
J [in]	0.94
K Shaft Diameter Maximum [in]	0.500
K Shaft Diameter Minimum [in]	0.499
L Minimum [in]	2.5185
L Maximum [in]	2.5193
M [in]	0.312
P [in]	0.125
Q [in]	0.20

### Weight

Weight [lb]	3.44
-------------	------