

## EZZE-MOUNT EZF-2020-34

Call 800-321-7800 or visit us online at [www.nookindustries.com](http://www.nookindustries.com) to configure and order your EZZE-MOUNT EZF-2020-34 today!

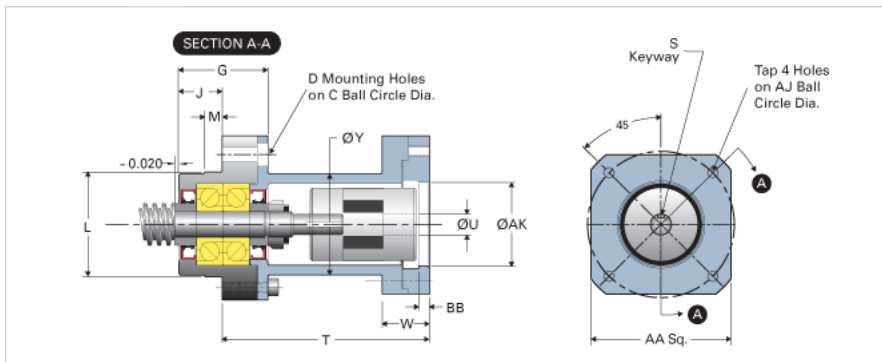

### Product Info

Part Number	EZF-2020-34
Reference Code	Y3
Machined End Code	20
Nema Frame Reference	34
Nominal Bearing Journal Size [mm]	20

### Dimensions

A [in]	3.38
AA [in]	3.44
AJ [in]	3.875
AK Maximum [in]	2.882
AK Minimum [in]	2.878
B - Diameter [in]	4.03
BB [in]	0.16
C Bolt Circle [in]	3.25
C Bore [in]	0.53
D Thru [in]	0.344
E [in]	4.03
F [in]	2.71
G [in]	1.98
H [in]	1.72
J [in]	1.03
K Shaft Diameter Maximum [in]	0.625
K Shaft Diameter Minimum [in]	0.624
L Maximum [in]	2.5185
L Minimum [in]	2.5193
M [in]	0.312
P [in]	0.188
Q [in]	0.20
S [in]	0.125
T [in]	4.92
U [in]	0.50
W [in]	1.67
Y [in]	2.37
TAP	#10-32