

EZZE-MOUNT EZF-3017-34

Call 800-321-7800 or visit us online at www.nookindustries.com to configure and order your EZZE-MOUNT EZF-3017-34 today!

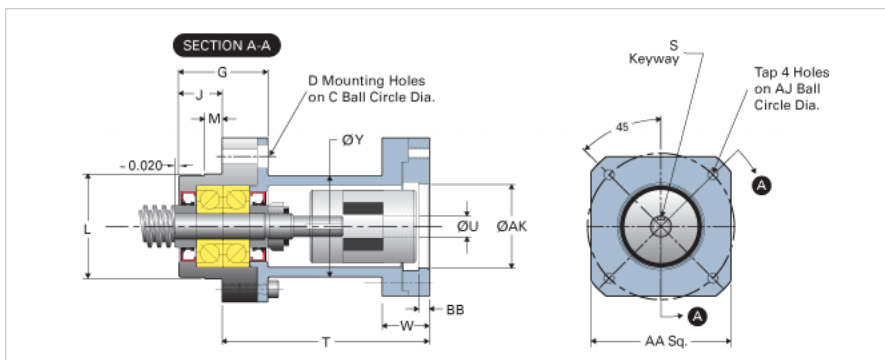

Product Info

Part Number	EZF-3017-34
Reference Code	Y3
Machined End Code	17
Nema Frame Reference	34
Nominal Bearing Journal Size [mm]	17

Dimensions

A [in]	3.38
AA [in]	3.25
AJ [in]	3.875
AK Maximum [in]	2.882
AK Minimum [in]	2.878
B - Diameter [in]	4.03
BB [in]	0.16
C Bolt Circle [in]	3.25
C Bore [in]	0.53
D Thru [in]	0.344
E [in]	3.65
F [in]	2.33
G [in]	1.93
H [in]	1.63
J [in]	0.94
K Shaft Diameter Maximum [in]	0.500
K Shaft Diameter Minimum [in]	0.499
L Maximum [in]	2.5185
L Minimum [in]	2.5193
M [in]	0.312
P [in]	0.125
Q [in]	0.20
S [in]	0.125
T [in]	4.62
U [in]	0.50
W [in]	1.67
Y [in]	2.25
TAP	#10-32