

## EZZE-MOUNT EZF-3015-23

Call 800-321-7800 or visit us online at [www.nookindustries.com](http://www.nookindustries.com) to configure and order your EZZE-MOUNT EZF-3015-23 today!

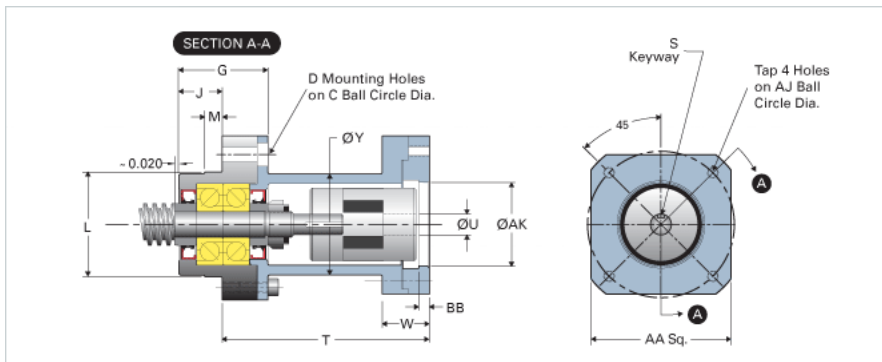
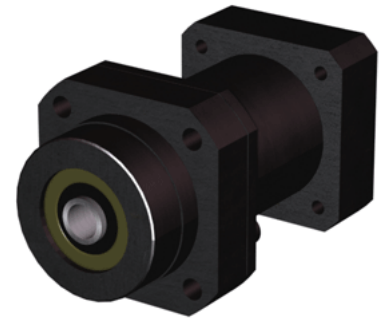

### Product Info

Part Number	EZF-3015-23
Reference Code	Y2
Machined End Code	15
Nema Frame Reference	23
Nominal Bearing Journal Size [mm]	15

### Dimensions

A [in]	2.70
AA [in]	2.50
AJ [in]	2.625
AK Maximum [in]	1.506
AK Minimum [in]	1.503
B - Diameter [in]	3.27
BB [in]	0.19
C Bolt Circle [in]	2.75
C Bore [in]	0.44
D Thru [in]	0.281
E [in]	3.50
F [in]	2.10
G [in]	1.71
H [in]	1.50
J [in]	0.88
K Shaft Diameter Maximum [in]	0.500
K Shaft Diameter Minimum [in]	0.499
L Maximum [in]	2.1250
L Minimum [in]	2.1256
M [in]	0.312
P [in]	0.125
Q [in]	0.20
S [in]	0.125
T [in]	3.84
U [in]	0.38
W [in]	0.88
Y [in]	1.98
TAP	#10-32