

EZZE-MOUNT EZF-3012-23

Call 800-321-7800 or visit us online at www.nookindustries.com to configure and order your EZZE-MOUNT EZF-3012-23 today!

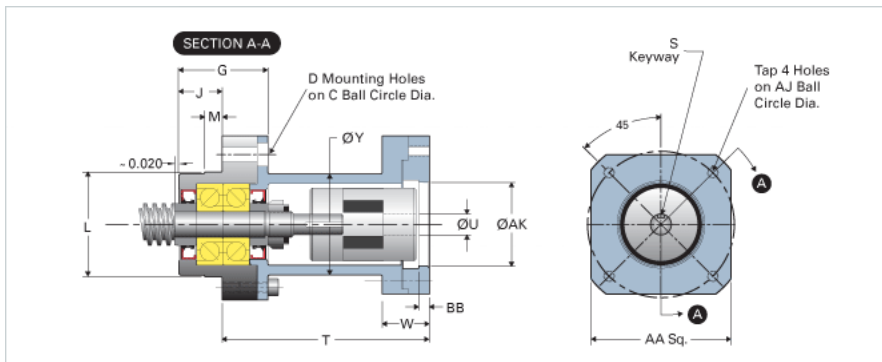

Product Info

Part Number	EZF-3012-23
Reference Code	Y2
Machined End Code	12
Nema Frame Reference	23
Nominal Bearing Journal Size [mm]	12

Dimensions

A [in]	2.50
AA [in]	2.50
AJ [in]	2.625
AK Maximum [in]	1.506
AK Minimum [in]	1.503
B - Diameter [in]	3.17
BB [in]	0.19
C Bolt Circle [in]	2.50
C'Bore [in]	0.44
D Thru [in]	0.266
E [in]	3.29
F [in]	1.99
G [in]	1.57
H [in]	1.38
J [in]	0.75
K Shaft Diameter Maximum [in]	0.406
K Shaft Diameter Minimum [in]	0.405
L Maximum [in]	1.8888
L Minimum [in]	1.8894
M [in]	0.312
P [in]	0.125
Q [in]	0.13
S [in]	0.125
T [in]	3.70
U [in]	0.38
W [in]	0.88
Y [in]	1.81
TAP	#10-32