

EZZE-MOUNT EZF-1008-17

Call 800-321-7800 or visit us online at www.nookindustries.com to configure and order your EZZE-MOUNT EZF-1008-17 today!

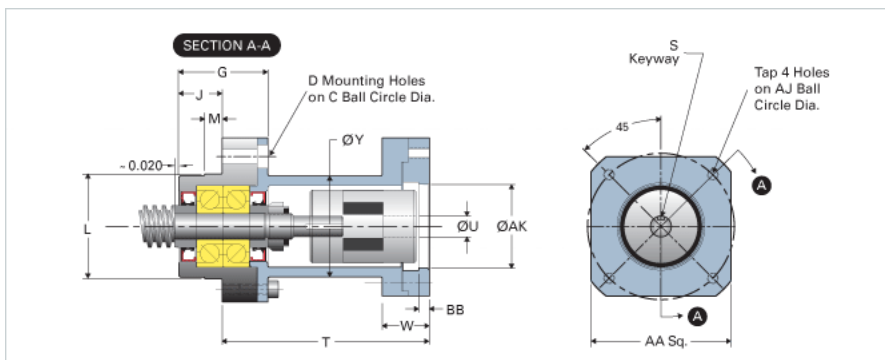

Product Info

Part Number	EZF-1008-17
Reference Code	Y1
Machined End Code	8
Nema Frame Reference	17
Nominal Bearing Journal Size [mm]	8

Dimensions

A [in]	1.88
AA [in]	1.75
AJ [in]	1.725
AK Maximum [in]	0.871
AK Minimum [in]	0.868
B - Diameter [in]	2.44
BB [in]	0.25
C Bolt Circle [in]	1.88
C Bore [in]	0.44
D Thru [in]	0.266
E [in]	2.00
F [in]	1.44
G [in]	1.06
H [in]	0.82
J [in]	0.50
K Shaft Diameter Maximum [in]	0.250
K Shaft Diameter Minimum [in]	0.249
L Maximum [in]	1.3770
L Minimum [in]	1.3775
M [in]	0.188
P [in]	0.094
Q [in]	0.13
S [in]	0.094
T [in]	2.84
U [in]	0.25
W [in]	0.52
Y [in]	2.20
TAP	#8-32