

ActionJac 25SS-MSJ-IR 10 2/3:1

Call 800-321-7800 or visit us online at www.nookindustries.com to configure and order your ActionJac 25SS-MSJ-IR 10 2/3:1 today!

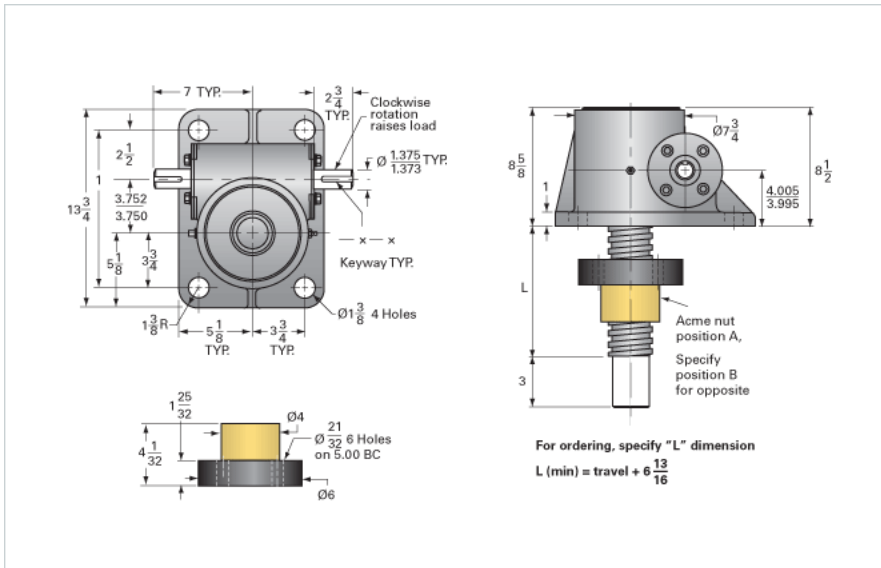
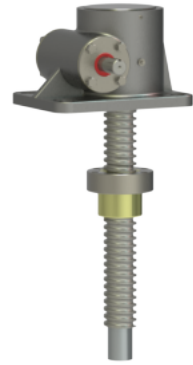

Details

Capacity [Ton]	8.30
Gear Ratio	10 2/3:1
Turns of Worm per Inch Travel	16
Torque to Raise 1 lb. [in-lb]	0.0452
Lifting Screw Diameter [in]	3.00
Screw Lead [in]	0.667
Root Diameter [in]	2.287
Tare Drag Torque [in-lb]	50

Performance Specifications

Maximum Allowable Input [hp]	11.00
Maximum Input Torque [in-lb]	903
Maximum Load at 1750 RPM	8764
Starting Torque	2 x Running Torque

Weight

Base 0 Travel [lb]	155
Per Inch of Travel [lb]	3.10
Grease [lb]	3.5